





**JAGWIRE™**

**We specialize in one thing, and we do it well.**

**Jagwire 只專心致力於一件事，並將它做到盡善盡美。**

Twenty-five years ago the Jagwire brand was born with the simple goal of providing the best shifting and braking systems for bicycle riders, dealers, and manufacturers. We're honored and humbled that our products have been so widely accepted in the industry for so many years and that our business continues to grow.

And while we're continuously focused on the future and developing the best assortment of bike products available, we want to take a few minutes to thank all of our partners and customers.

**Innovative, collaborative, passionate people.**

**創新·合作·熱情的團隊**

## INDEX 目錄

02	Cable	內線系統
03	Brake Housing	煞車外殼
04	Shift Housing	變速外殼
08	Housing Color	外殼顏色
10	Steering Cableset	轉向線組
13	Pro Dropper System	專業升降座管線控系統
16	Elite Link System	極致節式外殼系統
20	Elite Seal System	極致全防護系統
26	Installation Guide	零件配製圖
28	Housing Parts	外殼零件
34	Wire Holder	集線器
38	Tube Tops	保護套
39	Frame Parts	車架零件
40	Frame Plugs	車架塞蓋
42	Cable Parts	內線零件
44	Braking Parts	煞車零件
46	Adjuster	調整螺絲
49	Hydraulic System	油壓系列
60	Disc Brake Pads	來令片
66	Brake Pads	煞車皮

# Cable System 內線系統

## Elite



- ▲ Polished Ultra-slick cable with **Slick Lube** housing which delivers smooth braking performance.  
超低摩擦係數，搭配JAGWIRE全注油**Slick Lube**外殼，提供精準的變速/順暢的煞車手感
- ▲ **Uncoated cable makes easier installation.**  
奈米研磨無批覆層內線使組裝更加簡易
- ▲ STS-EL(Polished Ultra-Slick, Stainless)奈米級研磨不鏽鋼內線

## Pro



- ▲ Polished Slick Stainless: Slick Stainless cable with a Polishing process removes imperfections and makes surface smoother which can offer lower friction.  
不鏽鋼研磨內線加上拋光製程可移除不平整表面，讓線身更平整並且提供更低摩擦係數
- ▲ Uncoated cable makes easier installation  
拋光製程無批覆層內線使組裝更容易
- ▲ STS-PS(Polished Slick Stainless) 高精研磨不鏽鋼內線

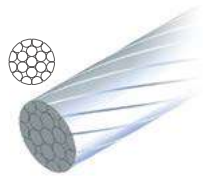

- ▲ Pre-stretching can more directly on the feedback of brake & precise shifting performance  
內線已做預拉整直可讓煞車回饋更直接與更精準的變速
- ▲ Smooth surface & low friction  
表面光滑&低摩擦力
- ▲ STS(Slick, Stainless)不鏽鋼研磨內線  
GAS(Slick, Galvanized)鍍鋅研磨內線

## Universal

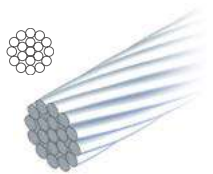

- ▲ Regular cable  
標準內線系統
- ▲ STR(Stainless Steel)不鏽鋼內線  
GAR(Galvanized Steel)鍍鋅內線

## Cable Nipple Options 內線鋅頭規格

Nipples are die-cast onto cable ends for durability and strength, adding to rider safety and confidence. All nipple types are compatible with any required cable specifications.

內線尾端的鋅頭是由鋅水經過鑄造程序所完成的，耐久性與強度提供了更安全與更安心的騎乘條件。所有的鋅頭樣式皆能夠符合目前所有煞車與變速系統的需求。

### Brake 煞車



B02 (7\*6)  
Shimano® & SRAM®  
MTB, BMX system compatible  
適用於Shimano® & SRAM®  
登山車, 表演車煞車系統

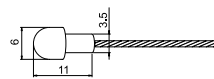

B04 (6\*11)  
Shimano® & SRAM®  
Road System compatible  
適用於Shimano® & SRAM®  
公路車系統

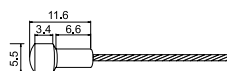

B05 (5.5\*11.6)  
Campagnolo®  
Road brake system compatible  
適用於Campagnolo®  
公路車煞車系統

### Derailleur 變速



D01 (4.3\*4.4)  
Shimano® & SRAM®  
shift system compatible  
適用於Shimano® & SRAM®  
變速系統

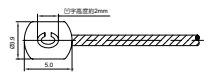

D02 (3.9\*5)  
Campagnolo® shift system  
compatible  
適用於Campagnolo®變速系統

# Brake Housing 煞車外殼

## Elite

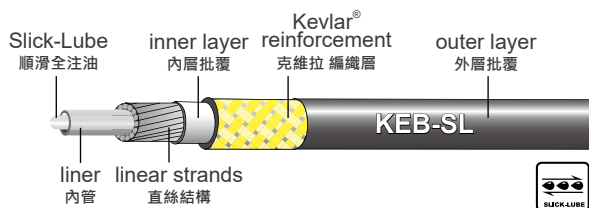

### KEB™

- ▲ Kevlar® brand fiber reinforced with compressionless housing for super braking  
Kevlar®(克維拉®)高性能纖維包覆著直絲結構鋼線提供高性能煞車
- ▲ Ideal for cable-actuated disc brakes  
機械式碟煞的最佳搭配首選
- ▲ Super light weight (30% less than standard coiled brake housing)  
輕量化(較一般環狀外殼輕30%)
- ▲ Hi-tech look  
高技術的外觀
- ▲ Compressionless  
零壓縮比
- ▲ Slick-Lube specified  
搭配順滑全注油內管
- ▲ 5.0mm Brake housing  
5.0mm 煞車外殼

**CAUTION:** Reinforced (linear shell) brake housing must be used with Jagwire specific lined alloy ferrules or POP adapters to ensure compressionless braking performance

**注意:** 直絲結構強化外殼使用於煞車線必須搭配Jagwire特殊襯裡鋁端套系列或POP端套系列已確保更完整的煞車性能。POP端套為V煞夾器彎管專門設計的

## Pro



### CGX-SL

- ▲ Low compression  
低壓縮比
- ▲ Low friction  
低摩擦係數
- ▲ With Slick Lube liner  
搭配順滑全注油內管

## Universal

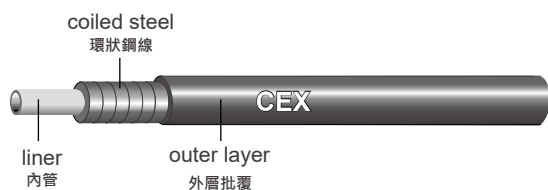

### CEX

- ▲ Regular housing  
標準外殼
- ▲ 5.0mm Brake housing  
5.0mm 煞車外殼

Note: Standard OD=5mm for Brake Housing  
備註: 煞車外殼標準外徑5mm

# Shift Housing 變速外殼

## Elite

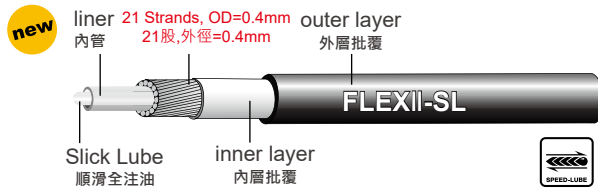

### FLEXII-SL

- ▲ Compressionless  
直絲結構·零壓縮比
- ▲ Ultra low friction  
超低摩擦係數
- ▲ With Slick Lube liner  
搭配順滑全注油內管
- ▲ Lighter (↓15%) & flexible (↑30%)  
輕量化(↓15%)&線身更加柔軟(↑30%)
- ▲ The flexible feature helps internal cables  
assemble more easy and efficiently.  
適用於內走線車架系統·使組裝更有效率

## Pro

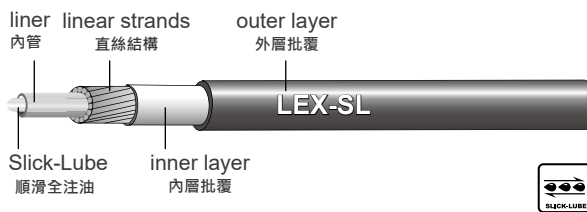

### LEX-SL

- ▲ Compressionless  
直絲結構·零壓縮比
- ▲ Low friction  
低摩擦係數
- ▲ With Slick Lube liner  
搭配順滑全注油內管

## Universal

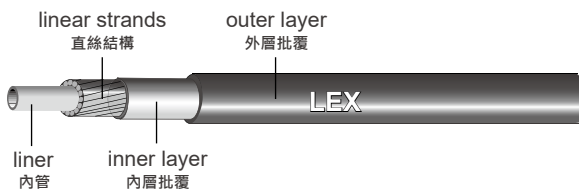

### LEX

- ▲ Compressionless  
直絲結構·零壓縮比
- ▲ Regular housing  
標準外殼

Note: Standard OD=4mm for Shift Housing. OD=4.5mm for Braided Series  
備註：變速外殼標準外徑4mm，編織系列外徑為4.5mm

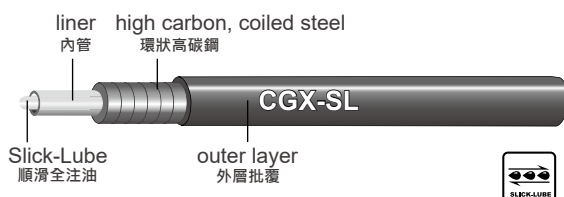

### CGX-SL

- ▲ OD=4mm, only recommended on rear shift area  
外徑4mm·只建議搭在後變後段
- ▲ Flexible structure  
結構柔軟
- ▲ Low friction  
低摩擦係數
- ▲ With Slick Lube liner  
搭配順滑全注油內管



JAGWIRE FLEX II-SL



JAGWIRE LEX-SL

JAGWIRE LEX-SL



## Housing Color 外殼顏色



# BICYCLE CABLE HOUSING 外殼系列

## Standard Series 標準系列

※All colors are available for Brake Housing (CEX, CGX-SL) and Shift Housing( LEX, LEX-SL) except #09.

各色均適用於煞車CEX,CGX-SL外殼系列與變速 LEX, LEX-SL外殼系列,除#09外

※#09 Translucent available with 5mm on coiled type housing only.

#09只提供5mm CEX環狀結構規格

※#01,#07,#35,#56 are available for CGX-SD, LEX-SD

#01,#07,#35,#56適用CGX-SD, LEX-SD

※#CB,#CC,#CD,#CE are available for LEX/CEX only.

#CB,#CC,#CD,#CE只適用LEX/CEX



## Frozen Series 平光系列

※All colors are available for Brake Housing( CGX-SL, CGX-SD) and Shift Housing( LEX-SL, LEX-SD)

各色均適用於煞車CGX-SL, CGX-SD外殼系列,與變速 LEX-SL, LEX-SD外殼系列



## ID-line 指示線系列

※All colors are available for Brake Housing (CGX-SL) and Shift Housing ( LEX-SL).

各色均適用於煞車CGX-SL外殼系列,與變速 LEX-SL外殼系列

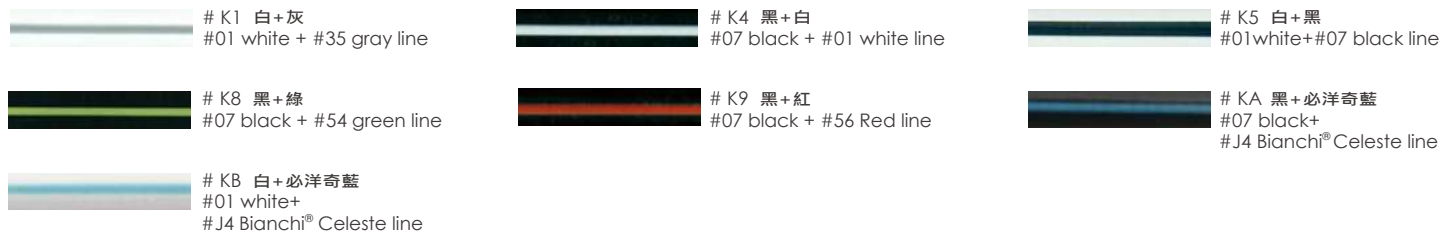

## Reflective Housing 反光系列

※All colors are available for Brake Housing( CEX, CGX-SL).

各色均適用於煞車CEX, CGX-SL外殼系列。





## Luminous 夜光系列

※All colors are available for **Shift Housing (LEX)**  
 各色均適用於變速LEX外殼系列







 # RC 白 White	 #RD 天空藍 Sky Blue	 # RR 螢光綠 Neon Green	 # RF 螢光橘 Neon Orange
---	--	---	--

## Braided Series 編織系列

※O.D. 5mm available for brake, O.D. 4.5mm available for shift.  
 煞車外殼外徑為5mm · 變速外殼外徑為4.5mm









※All colors are available for **Brake Housing (CGX-SL)** and **Shift Housing (LEX-SL)**.  
 各色均適用於煞車CGX-SL外殼系列與變速LEX-SL外殼系列

### Color options 可供選擇顏色

 # 95 編織棕 Braided carbon	 # 99 編織鈦 Braided titanium	 # A3 編織黑 Braided black	 # A9 細編織棕 Light braided carbon
 # N1 編織銀 Braided silver	 # N2 編織金 Braided gold	 # N3 細編織鈦 Light Braided titanium	 # M1 編織白 Braided white
 # M2 編織天空藍 Braided Sky Blue	 # M3 編織紅 Braided Red	 # B8 碳纖黑 Carbon Black	 # A5 細編織銀 Light Braided Silver
 # B1 細編織黑 Light Braided Black	 # 96 編織褐 Braided Bronze		

## KEB Reinforced Series KEB強化編織系列

※ All color available for **Brake Housing KEB-SL**  
 各顏色均適用於煞車KEB-SL外殼系列

 # 21 馬吉斯橘 Maxxis® Orange	 # B8 碳纖黑 Carbon Black	 # E4 神秘紫 Purple	 # 54 有機綠 Organic Green
 # 56 高貴紅 Red	 # E6 西帝藍 SID Blue	 #Q1 豔陽橘 Orange	 # E9 銀河灰 Ice Gray
 # 86 鵝黃 Yellow			

NOTE:MOQ requirement for some colors.

備註:特定顏色有最低購買量的限制

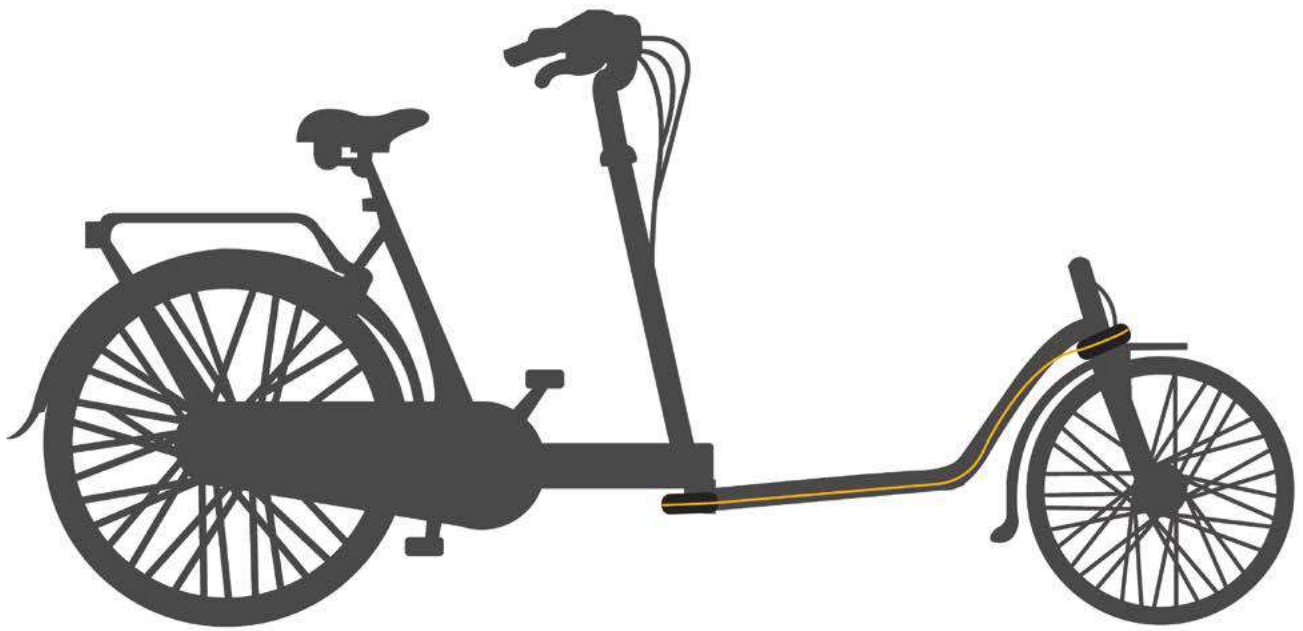

# Steering Cable set 轉向線組

## Housing 外殼

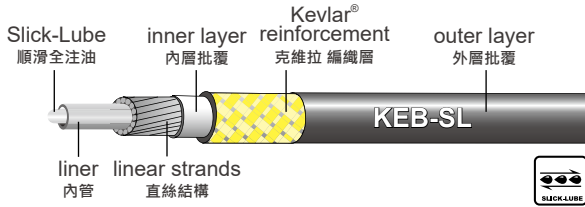

### KEB™

- ▲ OD=6mm  
外徑=6mm
- ▲ Kevlar® brand fiber reinforced with compressionless housing for super braking  
Kevlar®(克維拉®)高性能纖維包裹著直絲結構鋼線提供高性能煞車
- ▲ Super light weight (30% less than standard coiled brake housing)  
輕量化(較一般環狀外殼輕30%)
- ▲ Hi-tech look  
高技術的外觀
- ▲ Compressionless  
零壓縮比
- ▲ Slick-Lube specified  
搭配順滑全注油內管

## Cable 內線

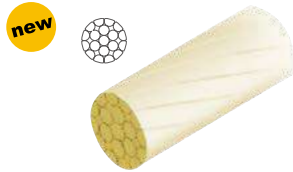

- ▲ OD=2mm  
外徑=2mm
- ▲ Polished Slick Stainless: Slick Stainless cable with a Polishing process removes imperfections and makes surface smoother which can offer lower friction.  
不鏽鋼研磨內線加上拋光製程可移除不平整表面，讓線身更平整並且提供更低摩擦係數
- ▲ Uncoated cable makes easier installation  
拋光製程無批覆層內線使組裝更容易
- ▲ STS-PS(Polished Slick Stainless)  
高精研磨不鏽鋼內線
- ▲ Pre-stretching reduces cable extensions and the frequency of cable length adjustments.  
內線預拉，可減少內線延伸及調整次數



- ▲ OD=2mm  
外徑=2mm
- ▲ STR(Stainless Steel)不鏽鋼內線

## Cable Nipple Options 內線鉗頭規格

Nipples are die-cast onto cable ends for durability and strength, adding to rider safety and confidence. All nipple types are compatible with any required cable specifications.

內線尾端的鉗頭是由鋅合金經過鑄造程序所完成的，耐久性與強度提供了更安全與更安心的騎乘條件。所有的鉗頭樣式皆能夠符合目前所有煞車與變速系統的需求。

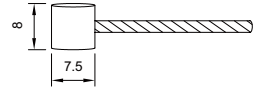
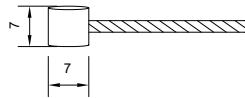
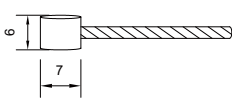

## Steering cable set Accessories 轉向線組系統零件

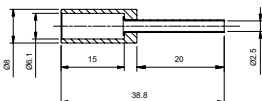
Part No.	Description	Material / Finish
 CM406	 Lined End Cap Fits 6mm housing 襯裡端套,適用6mm轉向線組外殼	Aluminum/Anodized 鋁/陽極

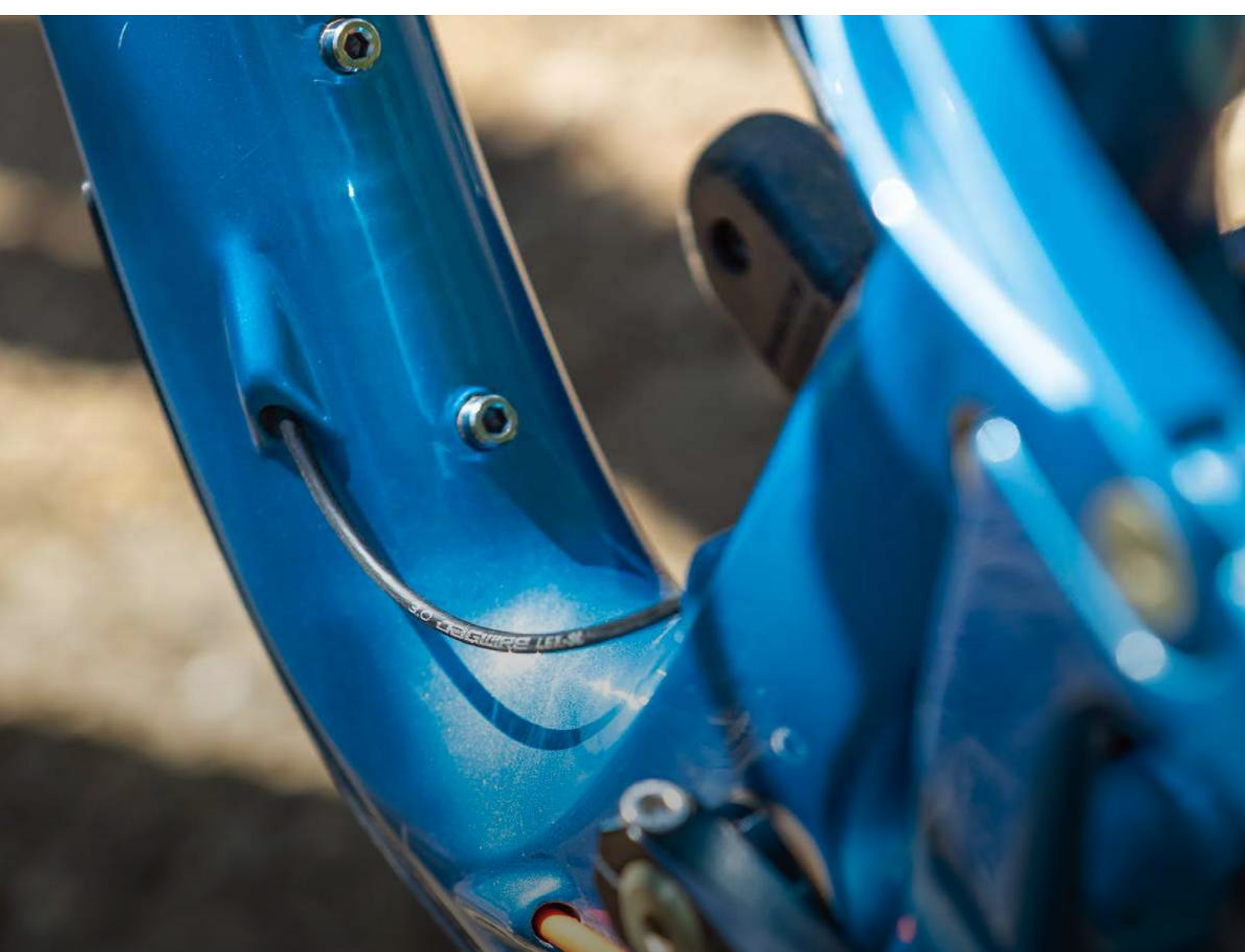

# Pro Dropper System 專業升降座管線控系統

## Housing 外殼

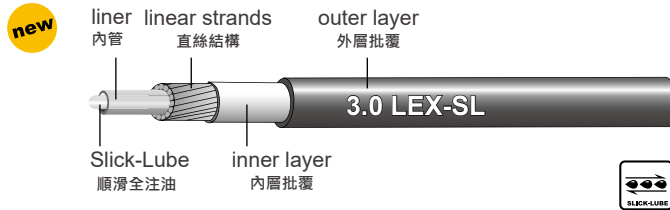

### 3mm LEX-SL

▲ OD=3mm  
外徑=3mm

- ▲ New flexible housing construction  
柔軟變速外殼結構
- ▲ With Slick Lube liner  
搭配順滑全注油內管

**CAUTION:** 3mm LEX-SL housing only can be applied with the Dropper system.

**注意:** 3mm LEX-SL外殼僅可使用在升降坐管線控系統。

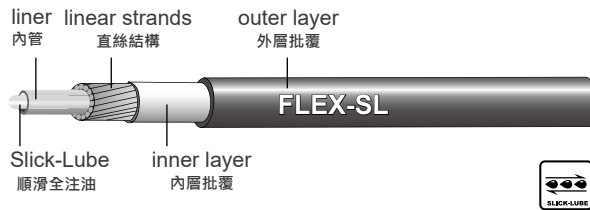

### 4mm FLEX-SL

- ▲ New flexible housing construction  
柔軟變速外殼結構
- ▲ With Slick Lube liner  
搭配順滑全注油內管



## Flexible Construction 結構柔軟

▲ Flexible shift housing and cable improves performance with internal routing and tight housing bends  
柔軟的外殼和內線搭配，可克服內走線較嚴苛的角度

## Color Options 可供選擇顏色

# 07 黑  
Black

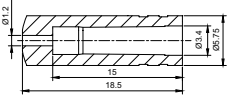
## Pro Dropper System Accessories 專業升降座管線控系統零件

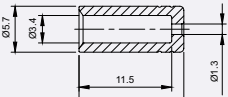
Part No.	Description	Material / Finish
<p><b>new</b></p> <p><b>CC1026DB</b></p>  	<p>Open End Cap Fits 3mm dropper housing</p> <p>標準端套,適用3mm升降座管外殼</p>	<p>Nylon/Black</p> <p>尼龍/黑色</p>
<p><b>new</b></p> <p><b>CC1043BJ</b></p>  	<p>Open End Cap Fits 3mm dropper housing</p> <p>標準端套,適用3mm升降座管外殼</p>	<p>Aluminum/Anodized</p> <p>鋁/陽極</p>

# Pro Dropper System

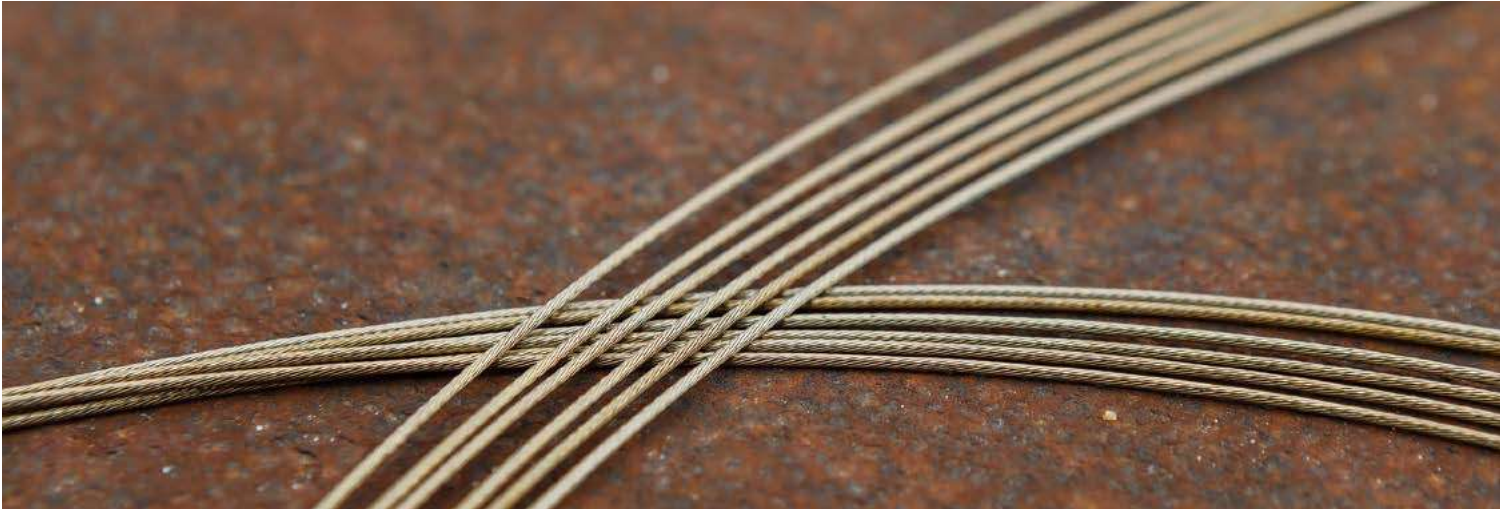

## Cable 內線

new

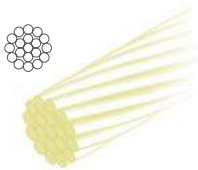

▲ OD=0.9mm  
外徑=0.9mm

- ▲ Polished Stainless: Stainless cable with a Polishing process removes imperfections and makes surface smoother which can offer lower friction.  
不鏽鋼內線加上拋光製程可移除不平整表面·讓線身更平整並且提供更低摩擦係數
- ▲ STR-PS(Polished stainless steel) 拋光不鏽鋼內線。

new

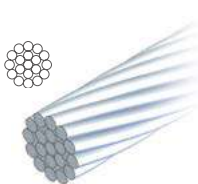



▲ OD=0.9mm  
外徑=0.9mm

- ▲ Lighter (↓40%) & flexible  
輕量化(↓40%) & 線身更加柔軟
- ▲ STR(Stainless Steel)不鏽鋼內線

## Enhanced Performance 增加做動順暢度

- ▲ 0.9mm Stainless Cable with slick-lube liner improves dropper post performance  
0.9mm不鏽鋼內線搭配注油外殼可增加伸縮座桿做動順暢度

Pro Dropper System Accessories 專業升降座管線控系統零件









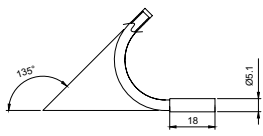

Part No.	Description	Material / Finish
<p>new</p> <p>CCG091UB-1</p>  	Heat Shrink Shims ID Ø1.5	
	熱縮套 內徑 Ø1.5	PO/Black
	Note: When you use a pointed set screw or bigger than a M4 screw, it must be assembled with a 0.9mm cable	PO塑膠/黑色
	備註: 使用尖頭或大於M4的止付螺絲需搭配熱縮套搭配0.9mm內線	

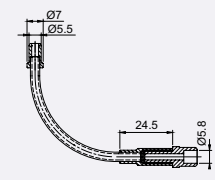

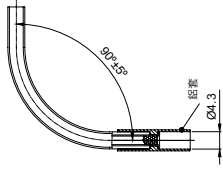
# 專業升降座管線控系統

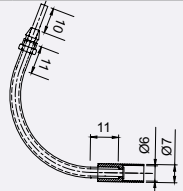

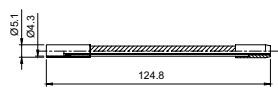
Guide Pipe 變速器彎管

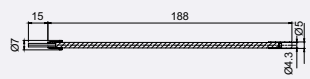
Part No.	Description	Material / Finish
<b>CCK034TB</b>  	Guide Pipe 135° 變速器彎管 135°	Stainless steel tube w/ aluminum end cap 不鏽鋼導管/鋁端套
<b>CCK028AJ</b>  	Guide Pipe 90° 變速器彎管 90°	Stainless steel tube w/ aluminum end cap 不鏽鋼導管/鋁端套
<b>CC727</b>  	Guide Pipe 90° 變速器彎管 90°	Stainless steel tube w/ aluminum end cap 不鏽鋼導管/鋁端套
<b>CCK029T9</b>  	Guide Pipe 110° 變速器彎管 110°	Stainless steel tube w/ aluminum end cap 不鏽鋼導管/鋁端套
<b>CC401-10</b>  	Guide Pipe 0 ~ 180° flexible 自由式變速器彎管 0 ~ 180°	Stainless steel tube w/ aluminum end cap 不鏽鋼導管/鋁端套
<b>CC994</b>  	Guide Pipe 0 ~ 180° flexible 自由式變速器彎管 0 ~ 180°	Stainless steel tube w/ aluminum end cap 不鏽鋼導管/鋁端套



## Link Brake and Shift Systems 節式外殼系統



### Compressionless, Aluminum link construction.

#### 全新的超低壓縮比節式結構

Aluminum link construction delivers some major benefits. It's compressionless delivering precision shifting, but it also allows for tight bends without kinking during tricky cable runs. It's also 20% lighter than traditional shift housing and 50% lighter than traditional brake housing. Combine these benefits with our slick-lube liners that dramatically reduce friction and you've got the best of performance and style.

全新的鋁製節式外殼結構設計，提供了大幅度的重量減輕、超低壓縮比，以及對應大角度彎曲的使用需求。搭配全順滑注油內管(Slick Lube)技術，提供絕佳的性能及與眾不同的風格。

### Reduced Weight 超輕量化

- ▲ 50% lighter than traditional brake housing  
較傳統煞車外殼結構輕量約50%
- ▲ 20% lighter than traditional shift housing  
較傳統變速外殼結構輕量約20%

### Compressionless Performance 超低壓縮比

- ▲ Compressionless aluminum construction delivers precision shifting and smooth, powerful braking  
超低壓縮比的設計結構，不僅提供了精準的變速效能，亦能強化敏銳的煞車手感

### Durable, Flexible Construction 靈活彎曲且耐用的結構

- ▲ Perfect for tricky cable runs with tight bends  
靈活對應大角度彎曲的使用需求

### Unique, Attention Grabbing Appearance 吸引目光的獨特設計

- ▲ Anodized finish is extremely durable and attractive  
兼具品味及質感的外型設計

### Standard Size 標準尺寸

PN:CC535

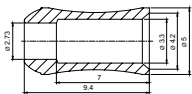

### Color Options 可供選擇顏色



# Elite LINK System

## Link Shift Accessories Link變速零件

Part No.	Road	MTB	Description	Material / Finish
CC996	1		Adjuster Adapter 調整螺絲轉接端套	Aluminum / Black 鋁/黑色
CC729BJ	1		Double-Ended 4mm Housing Connector 4mm外殼雙邊導引端套	Aluminum / Black 鋁/黑色
CC597BJ	6 7	2 3 6	End Cap For Connecting Link 4mm Shifting Housing 轉接端套-轉接Link端套 4mm變速外殼	Aluminum / Black 鋁/黑色
CC542BJ	6 7	2 4 5 6	End Cap For The End Of Link Link尾端端套	Aluminum / Black 鋁/黑色
CCG004QBG	7	6	Dirt Guard 橡膠防塵套	Rubber / Black 橡膠/黑色
CC538BJ	8	1 3 8	Adapter For Horn Of Link Tube 連接內管喇叭口	Aluminum / Black 鋁/黑色

## Link Brake Accessories Link煞車零件

Part No.	Road	MTB	Description	Material / Finish
CC539B	1		Adapter For Link and 5mm Braking Housing Link連接5mm煞車外殼	Aluminum / Black 鋁/黑色
CC541BJ	2 4 5	2 5 7 9 10	End Cap For The End Of Link Link尾端端套	Aluminum / Black 鋁/黑色
CC596BJ	2 3	2 3	End Cap For Connecting Link 5mm Braking Housing 轉接端套-轉接Link端套 5mm煞車外殼	Aluminum / Black 鋁/黑色
CC537BJ	3	1 3	Adapter For Horn Of Link Tube 連接內管喇叭口	Aluminum / Black 鋁/黑色
CC551BJ	4 5		Connector For C Type Braking Caliper C夾轉接端套	Aluminum / Black 鋁/黑色
CC544S		5 9	bent tube end cap for connecting link housing 彎管轉接端套	Aluminum / silver 鋁/銀色

Installation Guide  
零配件裝置圖

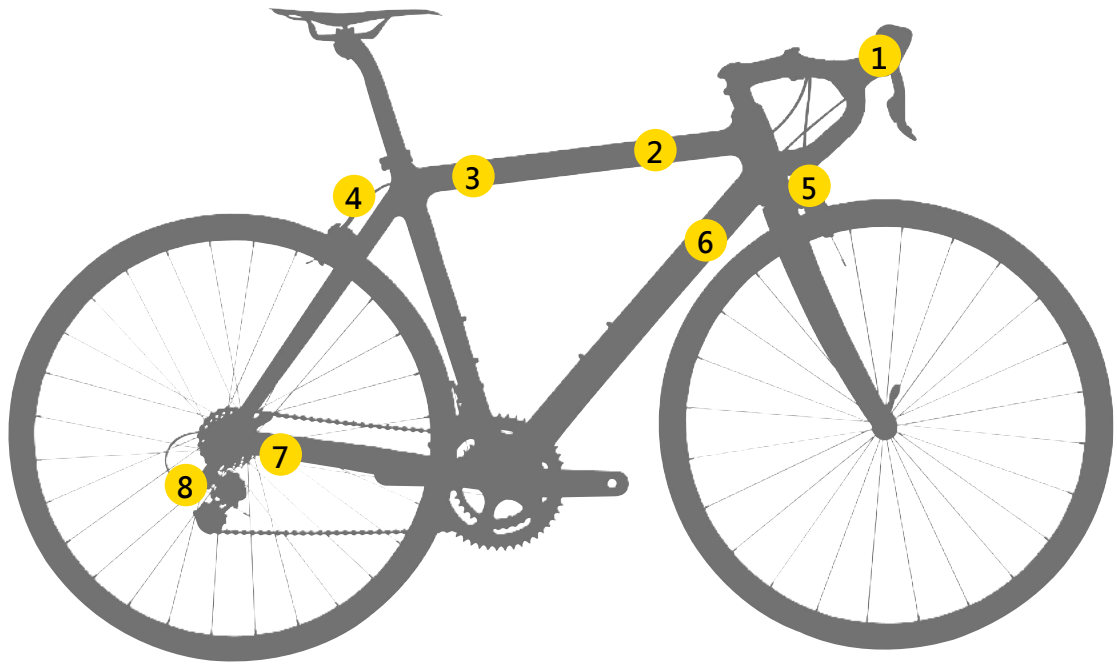

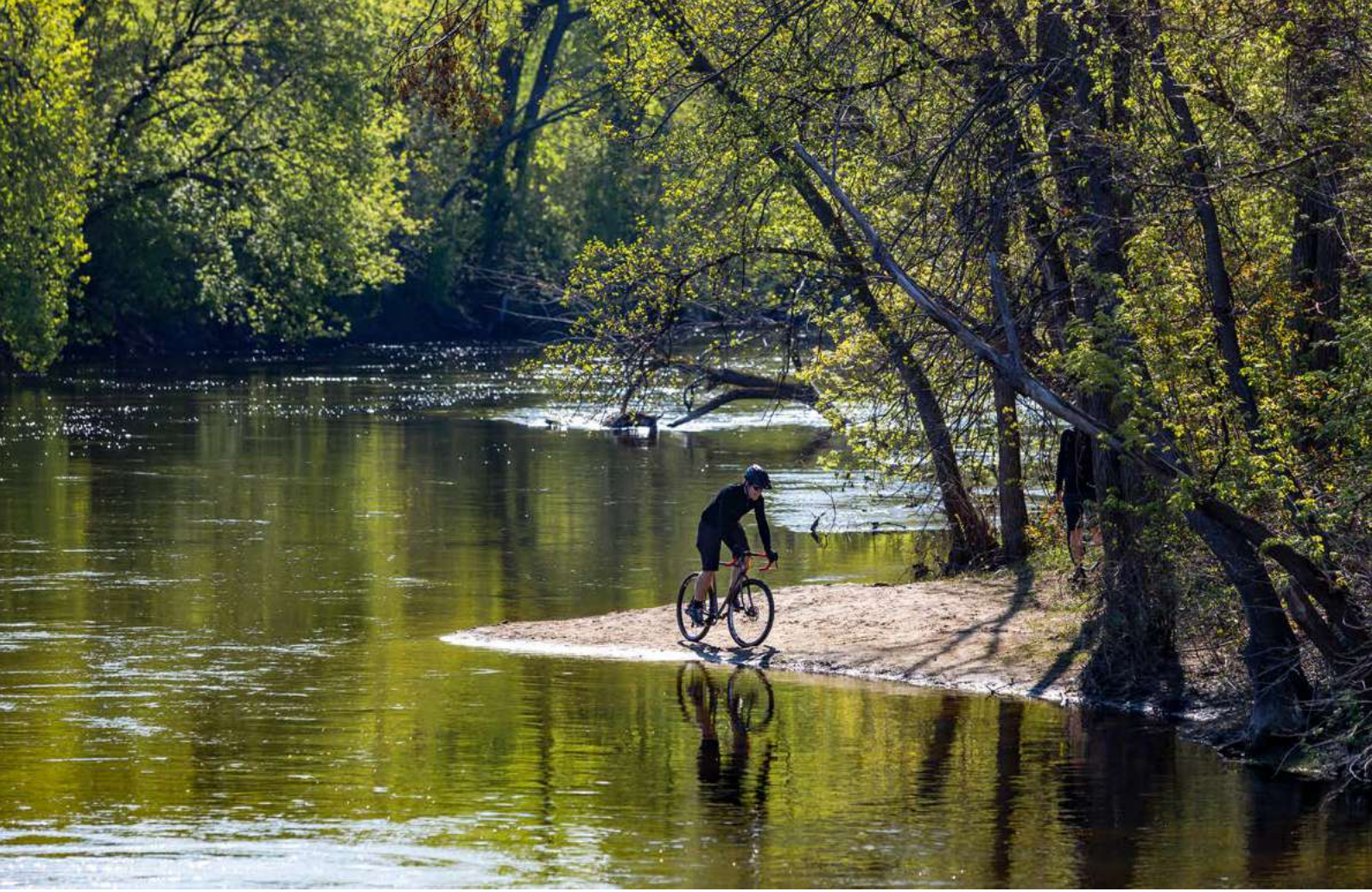

# Elite Sealed System 極致全防護系統

## Sealed Shift Housing 全防護變速外殼



▲ Weight: 40% less than LGX housing  
重量較LGX系統輕40%

▲ 5.0mm Shift housing  
5.0mm 變速外殼

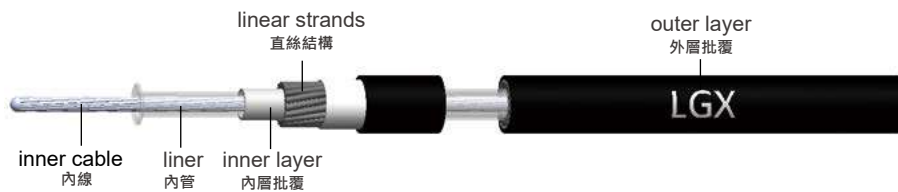

## Sealed Brake Housing 全防護煞車外殼



Jagwire sealed systems include liners that run continuously from the lever to the brake or derailleurs. This protects the cable and housing from dirt, mud or anything else that can cause friction. But because the liner runs the full length of the cable, a specially developed cable coating and lube are used to keep friction to a minimum. Jagwire 變速與煞車全防護系統採用從頭到尾的內管設計,完全阻隔任何會影響摩擦力的汙泥與雜質. 為了搭配全通內管,在外殼上開發特殊搭配低摩擦內線系統與新速動油品來達到極致低摩擦需求.

### Completely sealed 長效/阻絕汙泥

- ▲ Continuous liner running from the lever to the brake caliper could offer completely sealed to prevent dirt and debris  
全防護系統採用從手把端到卡鉗全內管防護,完全阻隔汙泥與雜質的影響

### Reduce friction 降低摩擦力

- ▲ Polymer coated cable and paired it with the new Speed-Lube ultra slick lubricate used throughout the liner could reduce friction  
搭配批覆內線與新速動全注油內管降低摩擦係數









### Color options 可供選擇顏色

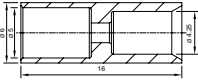

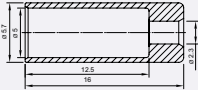

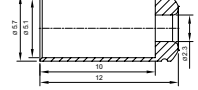
# Elite Sealed System

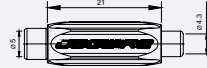

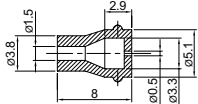
## Sealed System Shift Accessories 全防護系統變速零件

Part No.	Road	MTB	Description	Material / Finish
CC557BJ  	1		Adapter for 4mm LEX/ 5mm LGX/XEX 4mm LEX轉5mm LGX/XEX	Aluminum / Black 鋁/黑色
CC467BJ  	1 6 7 8	1 ~ 8	Standard End Cap For LGX/XEX LGX, XEX外殼標準端套	Aluminum / Black 鋁/黑色
CC115-3GB  	1 6 7 8	1 ~ 8	Standard End Cap For LGX/XEX LGX, XEX外殼標準端套	Brass / silver 銅/銀色
CM299BJ  	1		Inline Index Adjuster Adapter 4mm LEX/ 5mm LGX/XEX 定格式調整螺絲 4mm LEX轉5mm LGX/XEX	Alloy/Anodized/Black 鋁/陽極/黑色
CCG047B  	8 9	4 8	Grub Seals, Fits Seal system Brake and Shift liner 迷你密封保護套 適用於全防護系統煞車與變速內管	Silicon Gel /Black 矽膠/黑色

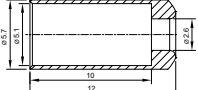
## Sealed System Brake Accessories 全防護系統煞車零件

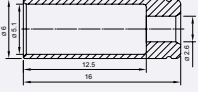
Part No.	Road	MTB	Description	Material / Finish
CC115-3GA  	1		Standard End Cap For CSX CSX外殼標準端套	Brass / silver 銅/銀色
CC466BJ  	2 3 4 5		Standard End Cap For CSX CSX外殼標準端套	Aluminum / Black 鋁/黑色



Installation Guide  
零配件裝置圖

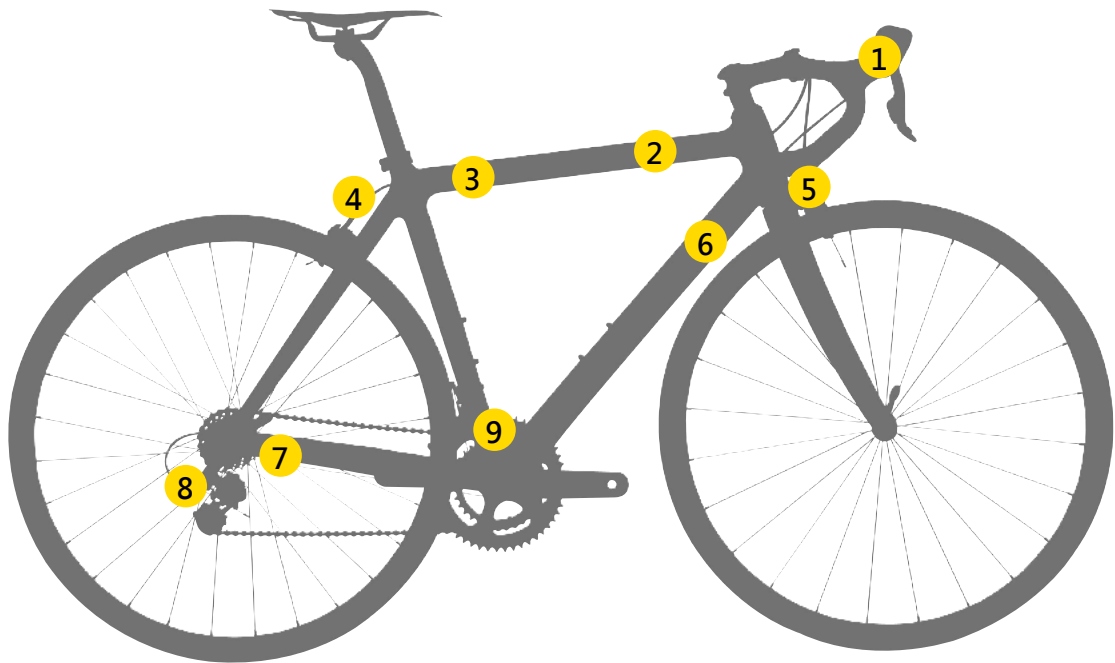



JAGWIRE LEX-SL

**Accessories**

配件



# INSTALLATION GUIDE 零配件裝置圖

Road Bicycle 公路車



**Foam tube**

發泡管

SFA07ANM

SFA07APM

SFA07ARM



**Adjuster Barrel**

調整螺絲

CM233-3BJ

CM093J



**Tube Tops**

保護套

CCG074-QBJ

CCG017-BJ, CCG025-BJ

CCG037

CCG043BJY

CCG052T



**Frame Plug**

車架塞蓋

CCN007NB

CCN078RB

CCN009

CCN81RB

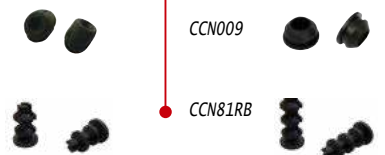

# INSTALLATION GUIDE 零配件裝置圖

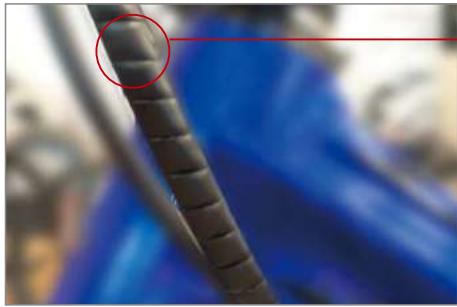

### Cable Management

集線管

CCZ107B

CCZ107T

CCZ129B

SH507AYM



### Rotating Hook

導管集線器

CM143W

CC1009A1B-J

CCZ101A1B

### EZ Clip Ring

導線開口環

CCQ023YBJ

CCQ024YBJ



### Adhesive Attached

電線固定貼

CM380B

CM381B



### Stick-on Guide

自黏式導線座系列



CME013B

CME011





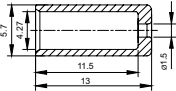





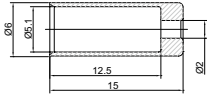

# ACCESSORIES

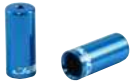
## Housing Parts

Open End Cap for Shift Housing 變速用標準端套

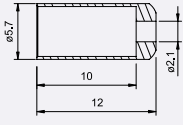
Part No.	Description	Material / Finish
 <p><b>CC464BJ</b> Black/黑色</p> <p><b>CC464CJ</b> CP/本色</p> <p><b>CC464OJ</b> Gold/金色</p> 	<p>Open End Cap, Fits 4mm Shifting housing (Recommended Use: SRAM® &amp; Shimano® Shiftig System)</p> <p>標準端套, 適用4mm變速外殼 (建議使用於SRAM® &amp; Shimano®系統)</p>	<p>Aluminum / Anodized 鋁/陽極</p>
 <p><b>CC464RJ</b> Red/紅色</p> <p><b>CC464SJ</b> Silver/銀色</p> <p><b>CC464UJ</b> Blue/藍色</p> <p><b>CC464EJ</b> Cash Green/美金綠</p>		
 <p><b>CC115-4I</b> Black/黑色</p> 	<p>Open End Cap (CNC), Fits 4mm thicker design for better enforcement</p> <p>標準端套(CNC車削), 適用4mm變速外殼· 前端加厚設計·強度增加</p>	<p>Brass / Zinc Plated 銅/鍍鋅</p>
 <p><b>CC115-4H</b> Black/黑色</p> <p><b>CC115-4HS</b> Silver/銀灰色</p> 	<p>Open End Cap, Fits 4mm housing</p> <p>標準端套, 適用4mm變速外殼</p>	<p>Brass/Chromed Black Zine /Silver Nickel 銅/三價鉻鍍黑鋅/銀鍍鎳</p>
 <p><b>CC115-4F</b> Black/黑色</p> <p><b>CC115-4FS</b> Silver/銀灰色</p> 	<p>Open End Cap, Fits 4mm housing</p> <p>標準端套, 適用4mm變速外殼</p>	<p>Plastic 塑膠</p>
 <p><b>CM115-4L</b> Black/黑色</p> <p><b>CM115-4N</b> silver/銀色</p> 	<p>Open End Cap (CNC) Fit 4.5mm Housing</p> <p>標準端套(CNC), 適用4.5mm外殼</p>	<p>Brass/Chromed Black Zine /Silver Nickel 銅/三價鉻鍍黑鋅/銀鍍鎳</p>

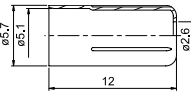
Open End Cap for Brake Housing 煞車用標準端套

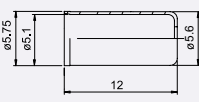









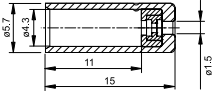



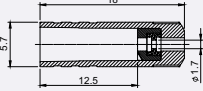

Part No.		Description	Material / Finish
 <p><b>CC715BJ</b> Black/黑色</p> <p><b>CC715CJ</b> CP/本色</p>	 <p><b>CC715OJ</b> Gold/金色</p>	 <p>Open End Cap, Fits 5mm Brake housing 標準端套, 適用5mm煞車外殼</p>	Aluminum/Anodized 鋁/陽極
 <p><b>CC715RJ</b> Red/紅色</p>	 <p><b>CC715SJ</b> Silver/銀色</p>	 <p><b>CC715UJ</b> Blue/藍色</p>	 <p><b>CC715EJ</b> Cash Green/美金綠</p>
 <p><b>CC115-3</b> Satin silver/銀色</p>	 <p><b>CC115-3E</b> Black/黑色</p>	 <p>Open End Cap (CNC), Fits 5mm CEX, CGX 標準端套(CNC車削), 適用 5mmCEX, CGX外殼, 前端加厚設計, 強度增加</p>	Brass/Chromed Black Zinc /Silver Nickel 銅/三價鉻鍍黑鋅/銀鍍鎳
 <p><b>CC115-2D</b> Satin silver/銀色</p>	 <p><b>CC115-2DE</b> Black/黑色</p>	 <p>Non-Crimping End Cap, Fits 5mm CEX, CGX Taiwan Patent: 158536 爪式端套, 適用5mmCEX、CGX外殼 台灣專利:158536</p>	Brass/Chromed Black Zinc /Silver Nickel 銅/三價鉻鍍黑鋅/銀鍍鎳
 <p><b>CC115-2</b> Satin silver/銀色</p>	 <p><b>CC115-2E</b> Black/黑色</p>	 <p>Open End Cap, Fits 5mm CEX, CGX 標準端套, 適用5mmCEX、CGX外殼</p>	Brass/Chromed Black Zinc /Silver Nickel 銅/三價鉻鍍黑鋅/銀鍍鎳

# ACCESSORIES

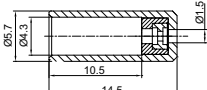
## Housing Parts

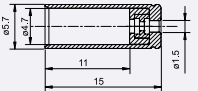
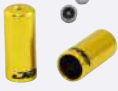











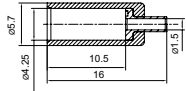

Sealed End Cap for Shift Housing 變速用油封端套

Part No.	Description	Material / Finish
 <p><b>CM176BJ</b> Black/黑色</p>	 <p>Sealed End Cap, Fits 4mm LEX-SL housing 油封端套, 適用4mm LEX-SL變速外殼</p>	<p>Aluminum / Anodized 鋁/陽極</p>
 <p><b>CM176OJ</b> Gold/金色</p>	 <p><b>CM176RJ</b> Red/紅色</p>	 <p><b>CM176SJ</b> Silver/銀色</p>
 <p><b>CM176UJ</b> Blue/藍色</p>	 <p><b>CM176EJ</b> Cash Green/美金綠</p>	
 <p><b>CM007</b> Black/黑色</p>	 <p><b>CM007S</b> Silver/銀灰色</p>	 <p>Sealed End Cap, Fits 4mm LEX-SL housing 油封端套, 適用4mm LEX-SL變速外殼</p> <p>Plastic 塑膠</p>
 <p><b>CM207-A</b> Black/黑色</p>	 <p>Sealed End Cap, Fits 4mm LEX-SL housing 油封端套, 適用於4mm LEX-SL外殼</p> <p>Brass / Zinc Plated 銅/鍍鋅</p>	
 <p><b>CM174BJ</b> Black/黑色</p>	 <p>Sealed End Cap, Fits 4.5mm LEX-SL housing 油封端套, 適用4.5mm LEX-SL變速外殼</p>	<p>Aluminum / Anodized 鋁/陽極</p>
 <p><b>CM174OJ</b> Gold/金色</p>	 <p><b>CM174RJ</b> Red/紅色</p>	 <p><b>CM174SJ</b> Silver/銀色</p>
 <p><b>CM174UJ</b> Blue/藍色</p>	 <p><b>CM174EJ</b> Cash Green/美金綠</p>	

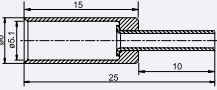







Lined End Caps 襯裡端套



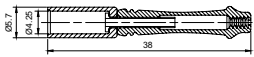

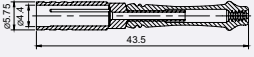
Part No.	Description	Material / Finish
 <p><b>CM251BJ</b> Black/黑色</p>	 <p>Short Lined End Cap Fits 4mm housing 短襯裡端套, 4mm外殼使用</p>	<p>Aluminum / Anodized 鋁/陽極</p>
 <p><b>CM251OJ</b> Gold/金色</p>	 <p><b>CM251RJ</b> Red/紅色</p>	 <p><b>CM251SJ</b> Silver/銀色</p>
 <p><b>CM251UJ</b> Blue/藍色</p>	 <p><b>CM251EJ</b> Cash Green/美金綠</p>	
 <p><b>CM173BJ</b> Black/黑色</p>	 <p>Lined End Cap, Fits 5mm Brake housing, built-out polymer nose, prevents abrasion of coated cables and reduces friction 襯裡端套, 適用5mm剎車外殼, 防止刮傷內線批覆層並減少摩擦</p>	<p>Aluminum/Anodized 鋁/陽極</p>
 <p><b>CM173OJ</b> Gold/金色</p>	 <p><b>CM173RJ</b> Red/紅色</p>	 <p><b>CM173SJ</b> Silver/銀色</p>
 <p><b>CM173UJ</b> Blue/藍色</p>	 <p><b>CM173EJ</b> Cash Green/美金綠</p>	

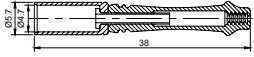

### Dirt Guard 防汙泥端套組

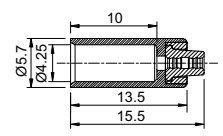

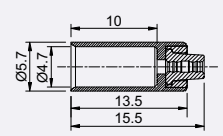

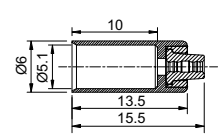
Part No.	Description	Material / Finish
<p><b>CM261BJ</b> Black/黑色</p>  	<p>Dirt Guard Kit, Fits 4mm Shifting housing, Prevent dust from entering the housing</p> <p>防汙泥端套組, 適用4mm變速外殼, 防止髒汙進入外殼</p>	<p>Aluminum /Anodized Silicone Gel /Black</p> <p>鋁/陽極 矽膠/黑色</p>
<p><b>CM276</b> Black/黑色</p>  	<p>Dirt Guard Kits, Fits 4mm housing, Prevent dust from entering the housing</p> <p>防汙泥端套組, 適用於4mm外殼,防止髒汙進入外殼</p>	<p>Plastic/ Silicone Gel/ Black 塑膠/矽膠/黑色</p>
<p><b>CM262BJ</b> Black/黑色</p>  	<p>Dirt Guard Kit, Fits 4.5mm Shifting housing, Prevent dust from entering the housing</p> <p>防汙泥端套組, 適用4.5mm變速外殼, 防止髒汙進入外殼</p>	<p>Aluminum /Anodized Silicone Gel /Black</p> <p>鋁/陽極 矽膠/黑色</p>

Hooded End Cap 防汙泥端套(精實版)

Part No.	Description	Material / Finish
 <p><b>CM260OJ</b> Gold/金色</p> <p><b>CM260BJ</b> Black/黑色</p>	 <p>Hooded End Cap Fits 4mm Shifting housing, An Extra layer of protection against dirt</p> <p>防汙泥端套(精實版) 適用於4mm外殼 增加結構防止髒汙進入</p>	<p>Alloy/ Anodized/Gold/Black NBR / Black</p> <p>鋁/陽極/金色/黑色 橡膠/黑色</p>
 <p><b>CM271OJ</b> Gold/金色</p> <p><b>CM271BJ</b> Black/黑色</p>	 <p>Hooded End Cap Fits 4.5mm Shifting housing, An Extra layer of protection against dirt</p> <p>防汙泥端套(精實版) 適用於4.5mm外殼 增加結構防止髒汙進入</p>	<p>Alloy/ Anodized/Gold/Black NBR / Black</p> <p>鋁/陽極/金色/黑色 橡膠/黑色</p>
 <p><b>CM269OJ</b> Gold/金色</p> <p><b>CM269BJ</b> Black/黑色</p>	 <p>Hooded End Cap Fits 5.0mm brake housing, An Extra layer of protection against dirt</p> <p>防汙泥端套(精實版) 適用於5mm外殼 增加結構防止髒汙進入</p>	<p>Alloy/ Anodized/Gold/Black NBR / Black</p> <p>鋁/陽極/金色/黑色 橡膠/黑色</p>

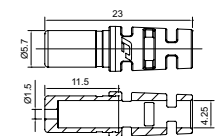
Anti-Kink End Cap 防折端套

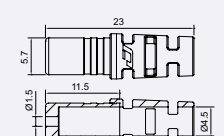

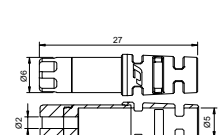





Part No.	Description	Material / Finish
 <p><b>CC976</b> Black/黑色</p>	 <p>Anti-kink End Cap Fits 4mm Housing</p> <p>防折端套 適用於4mm外殼</p>	<p>Plastic/Black</p> <p>塑膠/黑色</p>
 <p><b>CC977</b> Black/黑色</p>	 <p>Anti-kink End Cap Fits 4.5mm Housing</p> <p>防折端套 適用於4.5mm外殼</p>	<p>Plastic / Black</p> <p>塑膠/黑色</p>
 <p><b>CC978</b> Black/黑色</p>	 <p>Anti-kink End Cap Fits 5mm Housing</p> <p>防折端套 適用於5mm外殼</p>	<p>Plastic / Black</p> <p>塑膠/黑色</p>

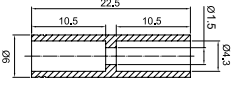

# ACCESSORIES

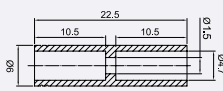
## Housing Parts

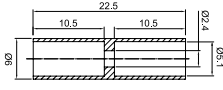
### Connect End Cap 連接端套

Part No.	Description	Material / Finish	
 <b>CC729SJ</b> Sliver/銀色	 <b>CC729BJ</b> Black/黑色	 Double-Ended Housing Connector 4.0 mm Derailleur Housing 雙邊外殼導引端套 4.0mm變速外殼	Aluminum 鋁
 <b>CC728SJ</b> Sliver/銀色	 Double-Ended Housing Connector 4.5 mm Derailleur Housing 雙邊外殼導引端套 4.5mm變速外殼	Aluminum 鋁	
 <b>CC328AS-J</b> Sliver/銀色	 <b>CC328AB-J</b> Black/黑色	 Double-Ended Housing Connector 5.0mm Brake housing 雙邊外殼導引端套 5.0mm煞車外殼	Aluminum 鋁

### POP End Cap POP轉接端套

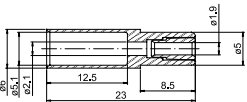
Part No.	Description	Material / Finish	
 <b>CM029SJ1</b> Sliver/銀色	 <b>CM029BJ</b> Black/黑色	 Fits 5mm Housing, designed specially for KEB® brake housing to work with a standard guide pipes and adjusters with a smaller inner diameter. 適用5mm外殼, 專為KEB外殼設計, 內縮設計剛好可放置於夾器內彎管	Aluminum / Anodized 鋁/陽極

### Other 其他零件

Part No.	Description	Material / Finish	
 <b>CC115-9</b> Black/黑色	 S Housing Holder, Fits 4 & 5mm housing S型導管集線器, 適用於4、5mm外殼	Plastic 塑膠	
 <b>CM143</b> Black/黑色	 <b>CM143W</b> White/白色	 Rotating Hook, Fits 4mm & 5mm housing Rotate 360° degrees 導管集線器,適用於4、5mm外殼 可360°旋轉	Plastic 塑膠
 <b>CM143-1</b> Black/黑色	 Rotating Hook, Fits 2.5mm E-shift & 5mm housing Rotate 360° degrees 導管集線器,適用於2.5mm電線及5mm 外殼可360°旋轉	Plastic 塑膠	
 <b>CCG060BJ</b> Black/黑色	 Wire Hook for Di2, Fits 2.5mm E-shift & 5mm housing 雙孔整線器 適用於2.5mm電線及5mm外殼	Silicone Gel 矽膠	











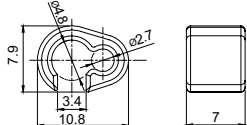

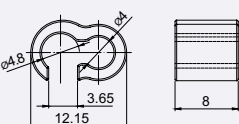

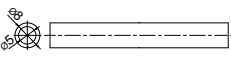
Other 其他零件

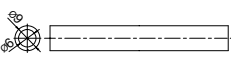
Part No.	Description	Material / Finish
<p>CC999BJ</p> 	 <p>Wire Hook for Di2 EW-SD50 Fits 2.5mm E-shift &amp; 5mm housing Open type 開放式雙孔整線器 適用於2.5mm電線及5mm外殼</p>	<p>Nylon/Black 尼龍/黑色</p>
<p>CC1009A1B-J</p> 	 <p>Wire Hook Fits 4mm &amp; 5mm housing Open type 開放式雙孔整線器 適用於4mm及5mm外殼</p>	<p>Nylon/Black 尼龍/黑色</p>
<p>CC1010A1B-J</p> 	 <p>Wire Hook Fits 4mm Shifting and E-system Housing Open type 開放式雙孔整線器 適用於4mm 變速· 電動車電線</p>	<p>Nylon/Black 尼龍/黑色</p>
<p>CC1012A1B-J</p> 	 <p>Wire Hook For Di2 EW-SD50 Fits 2.5mm E-shift and 4mm housing Open type 開放式雙孔整線器 適用於2.5mm電線及4mm外殼</p>	<p>Nylon/Black 尼龍/黑色</p>
<p>CC1020DB-J</p> 	 <p>Wire Hook Fits 5mm &amp; 5mm housing Open type 開放式雙孔整線器 適用於5mm&amp;5mm外殼</p>	<p>Nylon/Black 尼龍/黑色</p>
<p>CC1027DB-J</p> 	 <p>Wire Hook Fits 3mm &amp; 4mm housing Open type 開放式雙孔整線器 適用於3mm &amp; 4mm 外殼</p>	<p>Nylon/Black 尼龍/黑色</p>
<p>CC1028DB-J</p> 	 <p>Wire Hook Fits 3mm &amp; 5mm housing Open type 開放式雙孔整線器 適用於3mm &amp; 5mm 外殼</p>	<p>Nylon/Black 尼龍/黑色</p>
<p><b>new</b> CC1039DB-J</p> 	 <p>Wire Hook for Di2 EW-SD300 Fits 2.4mm &amp; 5mm housing Open type 開放式雙孔整線器 適用於2.4mm &amp; 5mm 外殼</p>	<p>Nylon/Black 尼龍/黑色</p>
<p>CCN062BJ</p> 	 <p>Wire Holder for E-bike E-bike集線器</p>	<p>Nylon/Black 尼龍/黑色</p>
<p>CM348BJ</p> 	 <p>Wire Holder with hook for E-bike 帶扣式E-bike集線器</p>	<p>Nylon/Black 尼龍/黑色</p>
<p>CCQ023YB-J</p> 	 <p>EZ Clip Ring ID Ø19mm, Open type Fits 3.2 mm wire 導線開口環 內徑 Ø19mm, 適用3.2mm電線</p>	<p>Nylon/Black 尼龍/黑色</p>
<p>CCQ024YB-J</p> 	 <p>EZ Clip Ring ID Ø28mm, Open type Fits 3.2 mm wire 導線開口環 內徑 Ø28mm, 適用3.2mm電線</p>	<p>Nylon/Black 尼龍/黑色</p>
<p>CC333-1</p> 	 <p>Housing Holder, Fits V-Brake 導管集線器, 適用於V型夾器後煞端</p>	<p>POM/Black 塑膠/黑色</p>
<p>CC1010AB</p> 	 <p>Housing Holder, 4mm &amp; 5mm 導管集線器 4mm &amp; 5mm</p>	<p>POM/Black 塑膠/黑色</p>

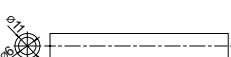
# ACCESSORIES

## Housing Parts

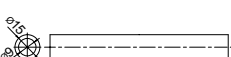
Other 其他零件

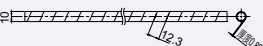
Part No.			Description	Material / Finish
CCZ101A1B			Wire Clip Fits 2.5mm E-shift & 5mm housing  集線夾 適用2.5mm電線&5mm外殼	Nylon/Black  尼龍/黑色
CC1021DB			Wire Clip Fits 4mm & 5mm housing  集線夾 適用4mm&5mm外殼	Nylon/Black  尼龍/黑色
SFA07ANM			Foam tube OD Ø8 *ID Ø5  發泡管 外徑Ø8*內徑Ø5	NBR/Black  橡膠/黑色
SFA07A5M			Foam tube OD Ø8.5*ID Ø5.5  發泡管 外徑Ø8.5*內徑Ø5.5	NBR/Black  橡膠/黑色
SFA07A7M			Foam tube OD Ø9*ID Ø6  發泡管 外徑Ø9*內徑Ø6	NBR/Black  橡膠/黑色
SFA07A6M			Foam tube OD Ø10*ID Ø7  發泡管 外徑Ø10*內徑Ø7	NBR/Black  橡膠/黑色
SFA07APM			Foam tube OD Ø11*ID Ø6  發泡管 外徑Ø11*內徑Ø6	NBR/Black  橡膠/黑色
SFA07ARM			Foam tube OD Ø11*ID Ø8  發泡管 外徑Ø11*內徑Ø8	NBR/Black  橡膠/黑色
SFA07AAM			Foam tube OD Ø15*ID Ø9  發泡管 外徑Ø15*內徑Ø9	NBR/Black  橡膠/黑色
SF301AKM			Foam tube OD Ø10*ID Ø6 (Fixed Length Cutting)  發泡管 外徑Ø10*內徑Ø6(定呎裁切)	EPE/White  珍珠棉/白色
CCZ107B			Spiral Wrapping Band OD: 10mm * Thickness: 0.8mm * Pitch: 12.3mm  捲式結束帶 外徑: 10mm * 厚度: 0.8mm * 螺距: 12.3mm	PE/Black  PE塑膠/黑色
CCZ107T			Spiral Wrapping Band OD: 10mm * Thickness: 0.8mm * Pitch: 12.3mm  捲式結束帶 外徑: 10mm * 厚度: 0.8mm * 螺距: 12.3mm	PE/Transparent  PE塑膠/透明







Other 其他零件

Part No.			Description	Material / Finish
CCZ129B			Spiral Wrapping Band OD: 4.5mm * Thickness: 0.6mm * Pitch: 6.5mm 捲式結束帶 外徑: 4.5mm * 厚度: 0.6mm * 螺距: 6.5mm	PE/Black PE塑膠/黑色
<b>new</b> SH507AYM			Abrasion Resistant Sleeve Open type, OD Ø5 (Fixed Length Cutting) 開放式耐磨編織管 外徑 Ø5 (定呎裁切)	PET/Black 塑膠/黑色
SH507AM			Abrasion Resistant Sleeve Open type, OD Ø8 (Fixed Length Cutting) 開放式耐磨編織管 外徑 Ø8 (定呎裁切)	PET/Black 塑膠/黑色
SH507AVM			Abrasion Resistant Sleeve Open type, OD Ø13 (Fixed Length Cutting) 開放式耐磨編織管 外徑 Ø13 (定呎裁切)	PET/Black 塑膠/黑色
SH507AXM			Abrasion Resistant Sleeve Open type, OD Ø25 (Fixed Length Cutting) 開放式耐磨編織管 外徑 Ø25 (定呎裁切)	Nylon/Black 尼龍/黑色
SAN07AWM			Nylon Tube OD: 6mm * 4.5mm Hardness: 80D 尼龍管 外徑: 6mm * 4.5mm 硬度: 80D	Nylon/Black 尼龍/黑色
SAN02AGM			Nylon Tube OD: 7mm * 5.5mm Hardness: 70D 尼龍管 外徑: 7mm * 5.5mm 硬度: 70D	Nylon/Transparent Black 尼龍/透明黑
SAN07AGM			Nylon Tube OD: 7mm * 5.5mm Hardness: 80D 尼龍管 外徑: 7mm * 5.5mm 硬度: 80D	Nylon/Black 尼龍/黑色
CM380B			Electric Cable Cover Fits 2.5mm cable Adhesive attached 電線固定貼 適用2.5mm電線 背膠設計	TPR/Black TPR橡膠/黑色
CM381B			Electric Cable Cover Fits 2.5mm cable Adhesive attached 電線固定貼 適用2.5mm電線 背膠設計	TPR/Black TPR橡膠/黑色
CM400			Cable connector 導線連接器組	Aluminum/Anodized/Black 鋁/陽極/黑色

# ACCESSORIES

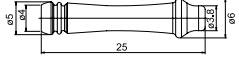
## Housing Parts

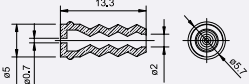
### Other 其他零件

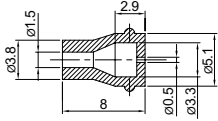









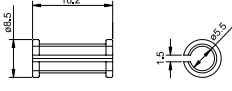

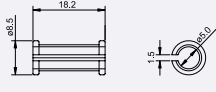

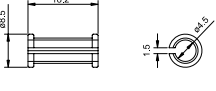

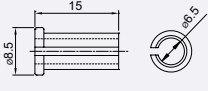
Part No.	Description	Material / Finish	
 <b>CCG004QBG</b> Black/黑色	 <b>CCG004QGG</b> Silver/銀色	 Dirt Guard Fits 4 & 4.5mm Nosed End Cap 橡膠防塵套, 適用4、4.5mm鼠尾端套	Silicone Gel 矽膠
 <b>CCG014B</b> Black/黑色	 <b>CCG014R</b> Red/紅色	 Dirt Guard, Fits 4mm & 4.5mm Nosed End Cap 外殼防水套, 適用於4mm、4.5mm鼠尾端套	Silicone Gel 矽膠
<b>CCG047B</b>		 Grub Seals, Fits Seal system Brake and Shift liner 迷你密封保護套 適用於全防護系統煞車與變速內管	Silicone Gel/Black 矽膠/黑色

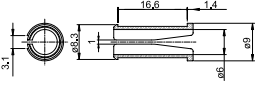
### Tube Tops 保護套系列

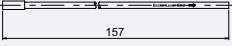
Part No.	Description	Material / Finish		
 <b>CCG074-QBJ</b> Black/黑色	 <b>CCG074-QWJ</b> White/白色	 Tube Tops 5G™ Frame Protector Fits 4, 4.5 & 5mm housing Clamp Type 5G雙開口式車架保護套 適用於4、4.5、5mm外殼	TPR TPR橡膠	
 <b>CCG017-BJ</b> Black/黑色	 <b>CCG017-WJ</b> White/白色	 Tube Tops 3G™ Frame Protector, Fits 4, 4.5 & 5mm housing Clamp Type 3G C型扣式車架保護套, 適用於4、4.5、5mm外殼	TPR TPR橡膠	
 <b>CCG025-BJ</b> Black/黑色	 <b>CCG025-WJ</b> White/白色	 Tube Tops 3G™ Frame Protector, Fits 5.5mm housing, Clamp Type 3G C型扣式車架保護套, 適用於5.5mm外殼	TPR TPR橡膠	
<b>CCG037</b>		 Tube Tops 4G, Frame Protector, Fit 4, 4.5 & 5mm housing, Slide type 4G車架保護套, 套入方式組裝, 適用於4、4.5、5mm外殼	Silicone Gel/Black Yellow logo 矽膠/黑色 黃色Logo	
 <b>CCG043BJY</b> Black/黑色	 <b>CCG043TJS</b> Translucent/透明	 Tube Tops™ Frame Protector, Fits 4, 4.5 & 5mm Frame, Slide type. 車架保護套, 以套入方式組裝, 適用於4、4.5、5mm外殼	Silicone Gel Yellow logo/Grey logo 矽膠 黃色Logo/ 灰色Logo	
 <b>CCG052B</b> Black/黑色	 <b>CCG052T</b> Translucent/半透明	 <b>CCG052R</b> Red/紅色	 Mini Tube Tops™ Frame Protector, Fits 4, 4.5 & 5mm housings, Slide type, 迷你型車架保護套, 以套入方式組裝, 適用於4、4.5、5mm外殼	Silicone Gel 矽膠

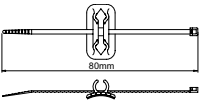

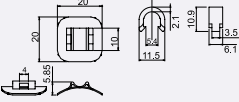

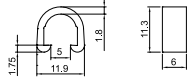

Frame Parts 車架零件

Part No.			Description	Material / Finish
CC359			Housing/Hose Guide Fits Frame Loops 5.5mm  車架止栓導管座, 適用於5.5mm外殼	Plastic / Black  塑膠/黑色
CC359-1			Housing/Hose Guide Fits Frame Loops 5mm  車架止栓導管座, 適用於5mm外殼	Plastic / Black  塑膠/黑色
CC359-2			Housing/Hose Guide Fits Frame Loops 4 & 4.5mm  車架止栓導管座, 適用於4、4.5mm外殼	Plastic / Black  塑膠/黑色
CC359-4			Housing/Hose Guide one side Fits Frame Loops 4 - 4.5mm  車架止栓導管座,單邊 適用於4、4.5mm外殼	Plastic / Black  塑膠/黑色
CC270-1			Housing/Hose guide frame loop Fits 4 & 5mm housings  車架止栓導管座,適用4、5mm外殼	Plastic / Black  塑膠/黑色
CM063			EZ-bend super-flexible housing segment is designed for easy set-up of Kevlar® reinforced compressionless housings on road bike handlebars  公路車手把專用導線連結彎管· 搭配KEB輕量化外殼專用	Steel W/Alloy End Caps  透明外殼/鋁端套
CME011			Stick-on Cable Guide, 3M adhesive attached  塑膠導線座, 3M背膠設計	Plastic / Black  塑膠/黑色
CME013B			Alloy Stick-on Cable Guide, 3M adhesive attached  鋁合金導線座, 3M背膠設計	Aluminum / Black  鋁/黑色
CME013S				
CCZ021PB			C Clip Frame Loop Housing Guide  C型車架止栓專用外殼扣環	Plastic/Black  塑膠/黑色

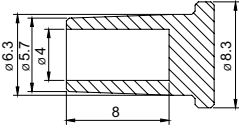
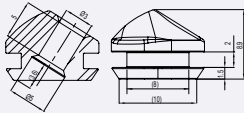

# ACCESSORIES

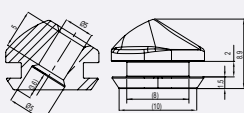
## Bicycle Frame Parts

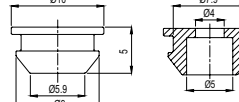
### Frame Plugs 車架塞蓋

Part No.	Image		Description	Material / Finish
CCN015			Plug for Internal Frame Routing For Close Type  車架止栓保護套 適用於無孔徑	EPDM / Black  橡膠/黑色
CCN007NB			Plug for Internal Frame Routing SHIMANO Di2 EW-SD50 2.0mm Frame  車架止栓/剖溝保護套 適用SHIMANO Di2 EW-SD50 車架厚度2.0mm	NBR / Black  橡膠/黑色
CCN007NB-1			Plug for Internal Frame Routing 4mm Derailleur Housing 2.0mm Frame  車架止栓/剖溝保護套 適用4mm變速外殼 車架厚度2.0mm	NBR / Black  橡膠/黑色
CCN007NB-2			Plug for Internal Frame Routing 5mm Brake Housing 2.0mm Frame  車架止栓/剖溝保護套 適用5mm煞車外殼 車架厚度2.0mm	NBR / Black  橡膠/黑色
CCN007NB-3			Plug for Internal Frame Routing SHIMANO Ultegra Di2 EW-SD300 2.0mm Frame  車架止栓/剖溝保護套 適用SHIMANO Ultegra Di2 EW-SD300 車架厚度2.0mm	NBR / Black  橡膠/黑色
CCN027-1			Plug for Internal Frame Routing 5mm Brake Housing 1.2mm Frame  車架止栓/剖溝保護套 適用5mm煞車外殼 車架厚度1.2mm	NBR/ Black  橡膠/ 黑色
CCN027-3			Plug for Internal Frame Routing 4mm Derailleur Housing 1.2mm Frame  車架止栓/剖溝保護套 適用4mm變速外殼 車架厚度1.2mm	NBR/ Black  橡膠/ 黑色
CCN027-5			Plug for Internal Frame Routing SHIMANO Di2 1.2mm Frame  車架止栓/剖溝保護套 適用SHIMANO Di2 車架厚度1.2mm	NBR/ Black  橡膠/ 黑色
CCN009			Plug for Internal Frame Routing For Close type  車架止栓保護套 適用於無孔徑	EPDM / Black  橡膠/黑色
CCN009-1			Plug for Internal Frame Routing SHIMANO Di2 EW-SD50  車架止栓/剖溝保護套 適用SHIMANO Di2 EW-SD50	EPDM / Black  橡膠/黑色
CCN009-2			Plug for Internal Frame Routing 4mm Derailleur Housing  車架止栓保護套 適用4mm變速外殼	EPDM / Black  橡膠/黑色

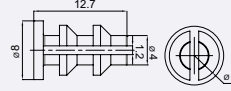
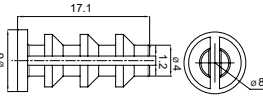
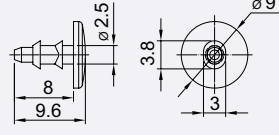
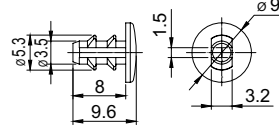
Frame Plugs 車架塞蓋

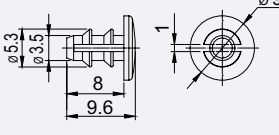









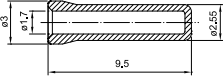



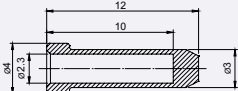

Part No.	Description	Material / Finish
<p>CCN009-3</p> 	 <p>Plug for Internal Frame Routing 5mm Brake Housing</p> <p>車架止栓/剖溝保護套 適用5mm剎車外殼</p>	<p>EPDM / Black</p> <p>橡膠/黑色</p>
<p><b>new</b> CCN009-5</p> 	 <p>Plug for Internal Frame Routing SHIMANO Ultegra Di2 EW-SD300 2.4mm</p> <p>車架止栓/剖溝保護套 適用SHIMANO Ultegra Di2 EW-SD300 2.4mm</p>	<p>EPDM / Black</p> <p>橡膠/黑色</p>
<p><b>new</b> CCN024-1</p> 	 <p>Plug for Internal Frame Routing 4mm Derailleur Housing</p> <p>車架止栓保護套 適用4mm變速外殼</p>	<p>EPDM / Black</p> <p>橡膠/黑色</p>
<p>CCN078RB</p> 	 <p>Plug for Internal Frame Routing Close type suggest on the Frame hole 5.7~6.0mm</p> <p>車架止栓保護套 無孔推薦於車架孔徑5.7-6.0搭配</p>	<p>Silicone Gel/ Black</p> <p>矽膠/黑色</p>
<p>CCN081RB</p> 	 <p>Plug for Internal Frame Routing Close type suggest on the Frame hole 6.0~6.3</p> <p>車架止栓保護套 無孔推薦於車架孔徑6.0-6.3搭配</p>	<p>Silicone Gel/ Black</p> <p>矽膠/黑色</p>
<p>CCN126EB</p> 	 <p>M4 Close Type Plug for Internal Frame Routing</p> <p>M4閉孔式塞蓋</p>	<p>EPDM/Black</p> <p>橡膠/黑色</p>
<p>CCN118NB</p> 	 <p>M5 Close Type Plug for Internal Frame Routing</p> <p>M5閉孔式塞蓋</p>	<p>EPDM/Black</p> <p>橡膠/黑色</p>
<p>CCN123NB</p> 	 <p>M6 Close Type Plug for Internal Frame Routing</p> <p>M6閉孔式塞蓋</p>	<p>EPDM/Black</p> <p>橡膠/黑色</p>
<p>CCN111EB</p> 	 <p>Plug for Internal Frame Routing</p> <p>車架止栓保護套 適用於無孔徑</p>	<p>EPDM / Black</p> <p>橡膠/黑色</p>
<p>CCG081EB</p> 	 <p>Shim fits with 2.5mm wire</p> <p>轉接襯條 適用於2.5mm電線</p>	<p>EPDM / Black</p> <p>橡膠/黑色</p>

# ACCESSORIES

Cable Parts













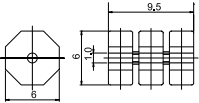
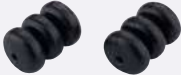

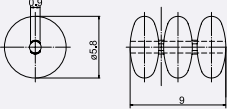

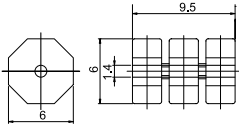
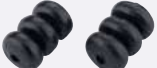

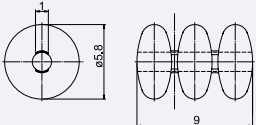



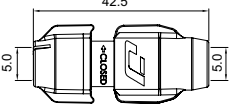

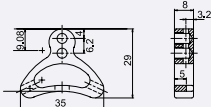
Cable Tips 線尾套系列

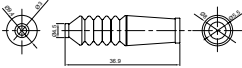
Part No.	Description	Material / Finish					
  <b>CC117-A</b> Silver/銀色	Cable Crimps, Fits 1.0 - 1.2mm cables, Open type  內線尾套, 適用1.0 - 1.2mm線徑 (變速內線適用)	Aluminum / Anodized  鋁/陽極					
 <b>CC117-AO</b> Gold/金色	 <b>CC117-AB</b> Black/黑色	 <b>CC117-A06</b> Red/紅色	 <b>CC117-AU</b> Blue/藍色	 <b>CC117-AK</b> Bianchi/必洋奇藍			
 <b>CC117-C</b> Silver/銀色	 <b>CC117-CO</b> Gold/金色	 Cable Crimps, Fit 1.0 - 1.8mm cables, Open type For Brake and shifting system  內線尾套,適用1.0 - 1.8mm線徑 (煞車、變速內線適用)	Aluminum / Anodized  鋁/陽極				
 <b>CC117-C06</b> Red/紅色	 <b>CC117-C07</b> Black/黑色	 <b>CC117-C08</b> Blue/藍色	 <b>CC117-C24</b> Pink/粉紅色	 <b>CC117-C61</b> Cash Green/綠色	 <b>CC117-C68</b> Purple/紫色	 <b>CC117-CJ6</b> Tango/橘色	 <b>CC117-CK</b> Bianchi/必洋奇藍

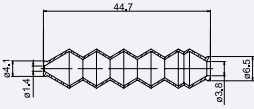

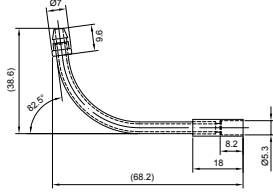
Cable Donuts 防刮墊圈系列

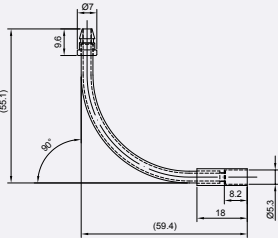
Part No.	Description	Material / Finish
 <p><b>CC170-B</b> Black/黑色</p>  <p><b>CC170-C</b> Translucent/透明</p> 	<p>Cable Donuts, Fit 1.1 - 1.2mm cables, Octagonal Shape</p> <p>O型環-八角形狀(內線防刮墊圈), 適用1.1 - 1.2mm線徑(變速內線)</p>	<p>Polymer 橡膠</p>
 <p><b>CC170-BO</b> Black/黑色</p>  <p><b>CC170-CO</b> Translucent/透明</p> 	<p>Cable Donuts, Fit 1.1 - 1.2mm cables, Round shape</p> <p>O型環-圓形形狀(內線防刮墊圈), 適用1.1 - 1.2mm線徑(變速內線)</p>	<p>Polymer 橡膠</p>
 <p><b>CC171-B</b> Black/黑色</p>  <p><b>CC171-C</b> Translucent/透明</p> 	<p>Cable Donuts, Fit 1.1 - 1.8mm cables, Octagonal Shape</p> <p>O型環-八角形狀(內線防刮墊圈), 適用1.1-1.8mm線徑(變速、煞車內線)</p>	<p>Polymer 橡膠</p>
 <p><b>CC171-BO</b> Black/黑色</p>  <p><b>CC171-CO</b> Translucent/透明</p> 	<p>Cable Donuts, Fit 1.1 - 1.8mm cables, Round Shape</p> <p>O型環-圓形(內線防刮墊圈), 適用1.1 - 1.8mm線徑(變速、煞車內線)</p>	<p>Polymer 橡膠</p>

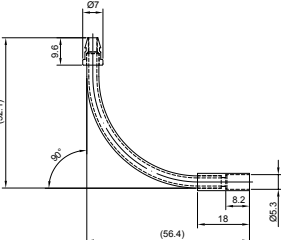
Part No.	Description	Material / Finish
<p><b>CM354BJ-4</b></p>  	<p>Brake Quick Release, designed for embedded brake system</p> <p>煞車快拆, 設計使用於直鎖式煞車夾器</p>	<p>Plastic / Zinc / Black</p> <p>塑膠/鋅/黑色</p>
<p><b>CC128-07</b></p>  	<p>Cable Hanger Fits Canti Brakes</p> <p>吊線座含內管 · 煞車夾器用</p>	<p>Aluminum / Black</p> <p>鋁/黑色</p>
<p><b>CCG044B</b></p>  	<p>V-Brake Pipe Boot</p> <p>V煞導管專用保護套</p>	<p>Rubber / Black</p> <p>橡膠/黑色</p>
<p><b>CC198</b></p>  	<p>V-brake pipe boot</p> <p>V煞導管專用保護套</p>	<p>Rubber / Black</p> <p>橡膠/黑色</p>
<p><b>CC220A</b></p>  	<p>Guide Pipe 82.5°</p> <p>煞車器彎管82.5°</p>	<p>Stainless steel tube w/ aluminum end cap</p> <p>不鏽鋼導管/鋁端套</p>
<p><b>CC221A</b></p>  	<p>Guide Pipe 90°</p> <p>煞車器彎管90°</p>	<p>Stainless steel tube w/ aluminum end cap</p> <p>不鏽鋼導管/鋁端套</p>
<p><b>CC221T</b></p>  	<p>Guide Pipe 90°</p> <p>煞車器彎管90°</p>	<p>Stainless steel tube w/ stainless end cap</p> <p>不鏽鋼導管/不鏽鋼端套</p>

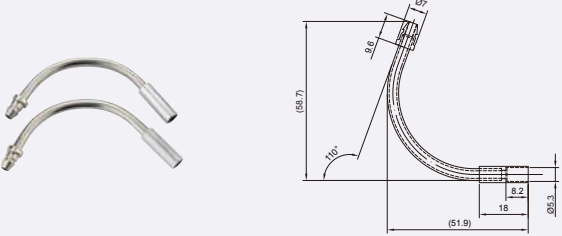
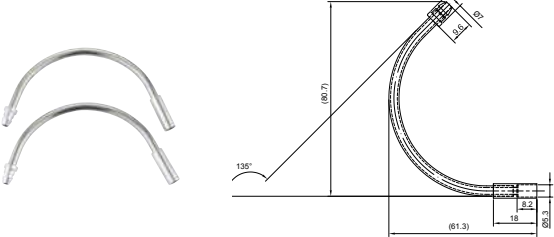
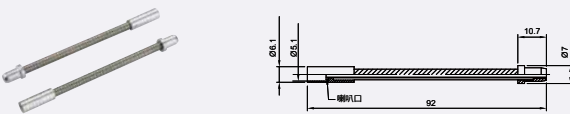
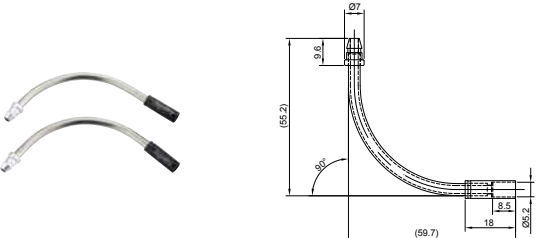
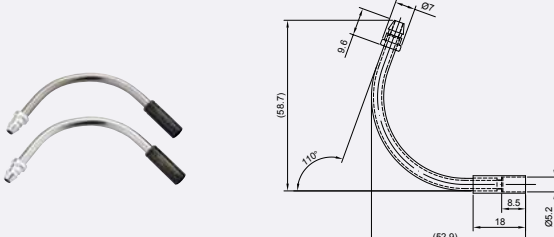
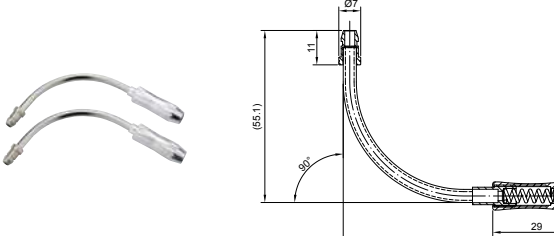
Part No.	Description	Material / Finish
<p><b>CC222T</b></p> 	<p>Guide pipe 110° 煞車器彎管110°</p>	<p>Stainless steel tube w/ stainless end cap 不鏽鋼導管/不鏽鋼端套</p>
<p><b>CC223A</b></p> 	<p>Guide pipe 135° 煞車器彎管135°</p>	<p>Stainless steel tube w/ aluminum end cap 不鏽鋼導管/鋁端套</p>
<p><b>CC401-2</b></p> 	<p>Guide pipe, 0~180° flexible 自由式煞車器彎管0°~180°</p>	<p>Stainless steel tube w/ aluminum end cap 不鏽鋼導管/鋁端套</p>
<p><b>CMD021B3</b></p> 	<p>POP guide pipe 90°, alloy end tips (designed specially for Kevlar® reinforced cable housing) POP煞車器彎管90°鋁端套,KEB輕量化外殼專用</p>	<p>Stainless steel tube w/ brass end cap 不鏽鋼導管/銅端套</p>
<p><b>CMD022B3</b></p> 	<p>POP guide pipe 110°, alloy end tips (designed specially for Kevlar® reinforced cable housing) POP煞車器彎管110°鋁端套,KEB輕量化外殼專用</p>	<p>Stainless steel tube w/ brass end cap 不鏽鋼導管/銅端套</p>
<p><b>CMD221S0</b></p> 	<p>Adjuster guide pipe 90° alloy end tips 90°鋁端頭轉接彎管 (內含彈簧緩衝結構)</p>	<p>Stainless steel tube w/ aluminum end cap 不鏽鋼導管/鋁端套</p>







Adjuster 調整螺絲

Part No.	Description	Material / Finish
<p><b>Rubberized coating</b></p>  <p><b>CM019B-1</b> Black/黑色</p> <p><b>CM019W</b> White/白色</p> 	<p>M5 index adjuster, Shimano® STI shifting cable boss compatible Taiwan Patent: 168957</p> <p>M5定格調整螺絲·公路車下管止栓用·適用於Shimano® STI系統 台灣專利:168957</p>	<p>Rubberized Cap/ Steel Bolt/Silver</p> <p>皮革漆/ 鐵螺絲/銀色</p>
<p><b>Rubberized coating</b></p>  <p><b>CM136B</b> Black/黑色</p> <p><b>CM136W</b> White/白色</p> 	<p>M5 index adjuster, Shimano® STI shifting cable boss compatible Taiwan Patent: 168957</p> <p>M5定格調整螺絲·公路車下管止栓用·適用於Shimano® STI系統 台灣專利:168957</p>	<p>Rubberized Cap/ Aluminum Bolt/Silver</p> <p>皮革漆/ 鋁螺絲/銀色</p>
<p><b>Rubberized coating</b></p> <p><b>CM160BJ</b></p>  	<p>Mini in-line adjuster Fits 4mm shift housing</p> <p>迷你同軸式調整螺絲 適用於4mm變速外殼</p>	<p>Aluminum / Rubberized coating</p> <p>鋁/皮革漆</p>
<p><b>CM093J</b></p>  	<p>Mini in-line adjuster Fits 4mm shift housing</p> <p>迷你同軸式調整螺絲 適用於4mm變速外殼</p>	<p>Aluminum / Anodized / Titanium finish</p> <p>鋁/陽極/鈦色</p>
<p><b>CM353B</b></p>  	<p>Inline index Adjuster Fits 4mm shift housing</p> <p>定格式調整螺絲 適用於4mm變速外殼</p>	<p>Plastic/Black</p> <p>塑膠/黑色</p>
<p><b>Rubberized coating</b></p> <p><b>CM157BJ</b></p>  	<p>Rocket adjuster, For Shimano® STI Shift Levers. Adds index adjustments at the lever.</p> <p>“火箭”調整螺絲·適用於Shimano STI公路車手把</p>	<p>Aluminum bolt / Argon plated / Black Rubberized cap / Black</p> <p>鋁螺絲/鍍鉻/黑 皮革漆/黑</p>

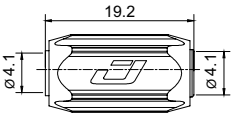
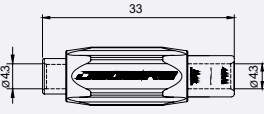

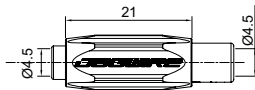

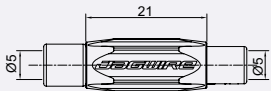
Part No.	Description	Material / Finish		
<b>CM233-3BJ</b> 	 <p>Mini-Inline index Adjuster Fits 4mm shift housing</p> <p>迷你定格式調整螺絲 適用於4mm變速外殼</p>	Aluminum/Anodized/Black 鋁/陽極/黑色		
<b>CM233-1DJ</b> Titanium/鈦色	<b>CM233-1BJ</b> Black/黑色	<b>CM233-1SJ</b> Silver/銀色	 <p>New- Inline Index/ Detent Adjusters Fits 4mm shift housing</p> <p>定格式調整螺絲 適用於4mm變速外殼</p>	Aluminum/Anodized 鋁/陽極
<b>CM272BJ</b>		 <p>New- Inline Index/ Detent Adjusters Fits 4.5mm shift housing</p> <p>定格式調整螺絲 適用於4.5mm變速外殼</p>	Aluminum/Anodized/Black 鋁/陽極/黑色	
<b>CM265BJ</b>		 <p>New-Inline index Adjusters Fits 5mm Brake housing</p> <p>定格式調整螺絲 適用於5mm煞車外殼</p>	Aluminum/Anodized/Black 鋁/陽極/黑色	

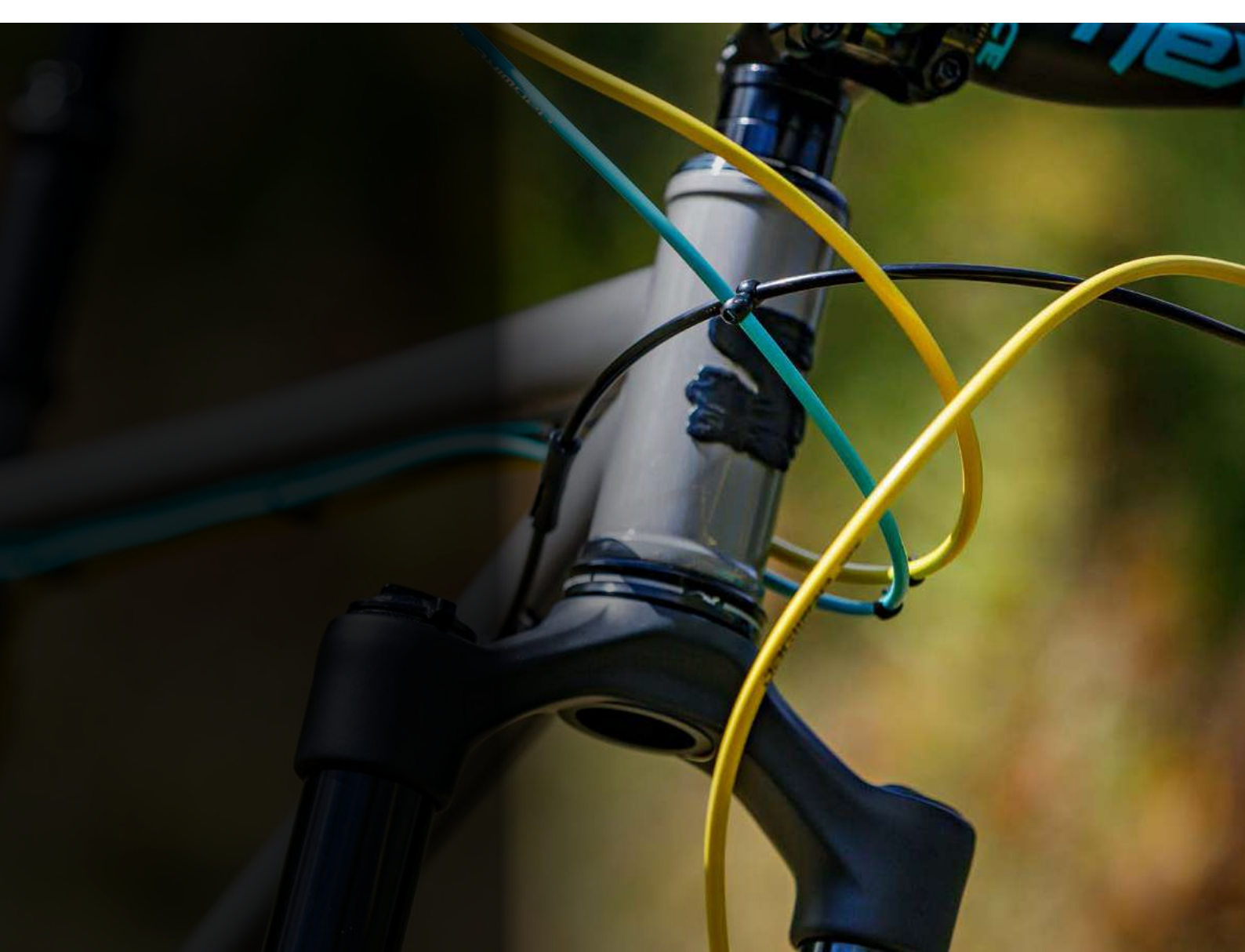

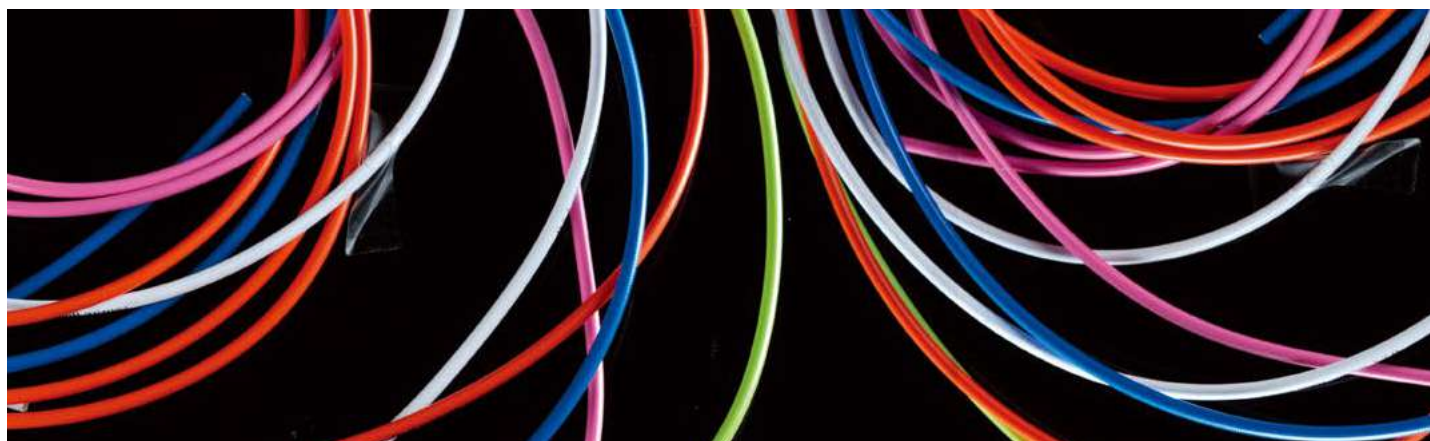

## Hydraulic Brake Hose 碟煞高壓油管



Item 項目	Dimension 尺寸	Tubing 內管	Reinforcement 編織層	Jacket 批覆層	Burst Strength 爆破係數	Compression 壓縮比		Color options 適用顏色
						at 1500psi	at 3000psi	
BE002	2.0 x 5.0	PBT	Polyester	Nylon	10000 psi+	1.7ml	3.9ml	Sole Colors單色系列
FK008	2.0 x 5.0	Tefzel®	Kevlar	Nylon	12000 psi+	1.6ml	3.7ml	Sole & Braided Color 單色&編織系列

### NOTE:

The hose materials and dimensions are available to specify according to requirements from customers. Featuring Jagwire Teflon® tubing is optional for high and low temperature resistance.

#### 注意:

高壓油管系列在原料與尺寸可依客戶特殊需求製作。  
Jagwire高壓油管特色在於可以承受高溫與低溫的使用條件

Available system: Shimano®、SRAM®、Magura®、Formula®、Hayes®、Hope®、Tektro®  
適用系統: Shimano®、SRAM®、Magura®、Formula®、Hayes®、Hope®、Tektro®

## Color Options 可供選擇顏色

### ▲ Sole Colors 單色系列

# 01 白  
White

# 07 黑  
Black

# Q1 艷陽橘  
Orange

# 54 有機綠  
Organic Green

# 56 高貴紅  
Red

# E6 西帝藍  
SID Blue

### ▲ Braided Series 編織系列

# N1 編織銀  
Braided silver



# N2 編織金  
Braided gold

#95 編織棕  
Braided carbon

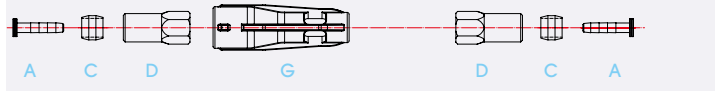
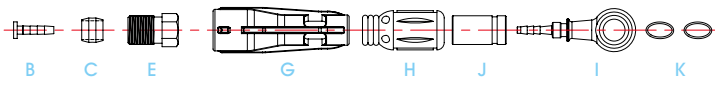
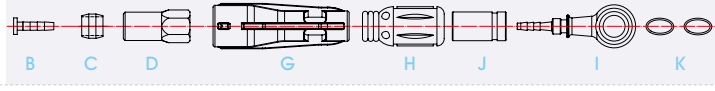
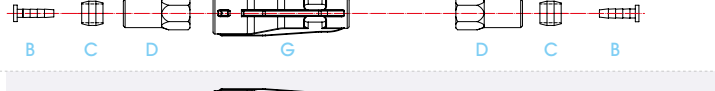

# ACCESSORIES

## Housing Parts

### Shimano Hydraulic Hose fittings 油管接頭零件

Part Number	Contain	Manufacturer	Compatible Models
S01		Shimano®	<ul style="list-style-type: none"> <li>● XTR M975</li> <li>● Deore XT M775</li> <li>● SLX M665</li> <li>● Deore LX T665, M585</li> <li>● Hone M601</li> <li>● Deore T615, M595, M535, M525</li> <li>● Alfine S500, S501</li> <li>● Metrea U5000</li> <li>● Alivio M4050</li> <li>● Acrea M3050</li> <li>● Non-Series T605, M447, MT500 M575, M486, M485, M446 M445, M395, M365, M355, M315</li> </ul>
S02		Shimano®	<ul style="list-style-type: none"> <li>● XTR M9020, M9000, M988, M987, M985</li> <li>● Saint M820</li> <li>● Deore XT M8000, M785, T785</li> <li>● SLX M7000, SLX M675, M666, ZEE M640</li> <li>● Alfine S700</li> </ul>
S03		Shimano®	<ul style="list-style-type: none"> <li>● Saint M810</li> </ul>
S04		Shimano®	<ul style="list-style-type: none"> <li>● Deore M6000, M596, M615</li> <li>● Deore LX T675</li> </ul>
S05 <small>FIT J-kit spec</small>		Shimano®	<ul style="list-style-type: none"> <li>● Road/CX RS805, RS785, RS505, RS405</li> </ul>
S06		Shimano®	<ul style="list-style-type: none"> <li>● R9120/R9170/R8070/R7070</li> </ul>

### Shimano®

Part No.	Description	Material / Finish
CC998 	Needle ( Inserts ) Fits BH59 Hydraulic Hose 油針 適用BH59油管	Brass 銅/本色
CC944 	Needle ( Inserts ) Fits BH90 Hydraulic Hose Fits Jagwire Hydraulic Hose 油針 適用BH90油管 適用Jagwire 油管	Stainless Steel 不鏽鋼/本色
CCC010 	Compression Bushing 迫緊環	Brass 銅/本色
CCA058IA 	Compression Nut ( External ) 迫緊螺絲 (外牙式)	Steel / Black 鐵/黑色
CCA071I10 	Compression nut ( External ) 迫緊螺絲 (外牙式)	Steel/ Chromed/Black 鐵/三價鉻鍍黑鋅/黑色

Shimano®

Part No.	Description	Material / Finish
<b>CCA125IA</b> <span style="border: 1px solid black; border-radius: 50%; padding: 2px;">F</span>  	Compression Nut (External) 迫緊螺絲(外牙式)	Steel/Chromed/Black 鐵/三價鉻鍍黑鋅/黑色
<b>CCG040-B</b> <span style="border: 1px solid black; border-radius: 50%; padding: 2px;">G</span>  	Caliper-End Protector Fits Brake Lever-end 保護套 適用於油壓碟剎把手端	Silicone Gel / Black 橡膠/黑色
<b>CCG005</b> <span style="border: 1px solid black; border-radius: 50%; padding: 2px;">H</span>  	Caliper - End Protector Fits Brake Caliper End 保護套 適用於油壓碟剎卡鉗端	Silicone Gel / Black 橡膠/黑色
<div style="background-color: yellow; border-radius: 50%; padding: 2px; display: inline-block;">new</div> <b>CCR075AC</b> <span style="border: 1px solid black; border-radius: 50%; padding: 2px;">I</span>  	Banjo end (Assembled parts only) 胡琴接頭 (以組件出貨)	Aluminium/Silver 鋁合金/本色
<b>CCF051T9</b> <span style="border: 1px solid black; border-radius: 50%; padding: 2px;">J</span>  	Compression nut (Assembled parts only) 壓著端端套 (以組件出貨)	Stainless Steel/Silver 不銹鋼/本色
<b>CCI010NR</b> <span style="border: 1px solid black; border-radius: 50%; padding: 2px;">K</span>  	O-Ring O型環油封	NBR/Red 橡膠/紅色

# HYDRAULIC SYSTEM





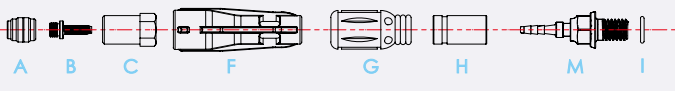
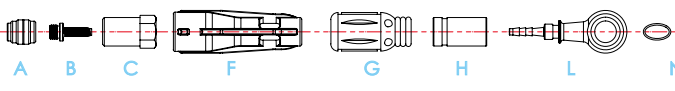
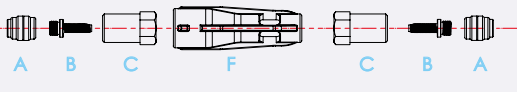
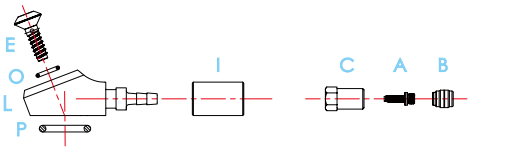
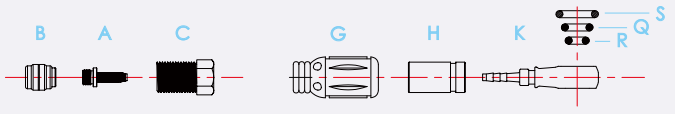
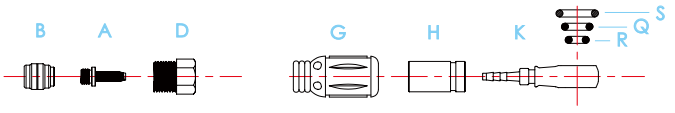







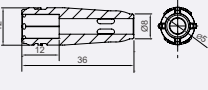

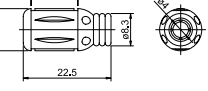

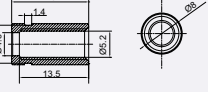

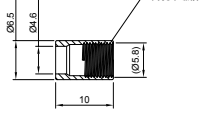

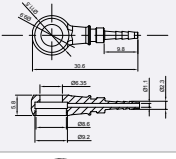

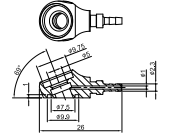

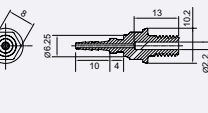

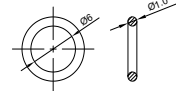
## Bicycle Hydraulic Disc Brake Parts

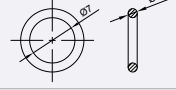
### Sram Hydraulic Hose fittings 油管接頭零件

Part Number	Contain	Manufacturer	Compatible Models
A02		SRAM®	<ul style="list-style-type: none"> <li>● SRAM® Guide RSC (A1), Guide RS (A1) Guide R (A1); Level TL; DB5</li> <li>● Avid® Elixir R, CR, CR Mag, 5, 7, 9, X0, XX2012+ XX World Cup 2012; 7 Trail, 9 Trail, X0 Trail</li> </ul>
A04 <small>FIT Stealth-a-majig</small>		SRAM®	<ul style="list-style-type: none"> <li>● SRAM® G2 Ultimate, G2 RSC, G2 RS, G2 R; Guide Ultimate, Guide RSC (B1), Guide RS (B1), Guide R (B1);</li> <li>● Avid® XX World Cup 2010-2011, XX™ 2010-2011; Juicy Ultimate™, Juicy Carbon, Juicy Seven™, Juicy Five™</li> <li>● LEVEL TLM, Ultimate CODE 2018 R. RSC</li> </ul>
A05 <small>FIT Stealth-a-majig</small>		SRAM®	<ul style="list-style-type: none"> <li>● Juicy3</li> <li>● CODE COD2008-2010, 5, 7, R 2011, 2017</li> <li>● Elixie 1, 3</li> <li>● DB 2016 1, 3, 2017 1, 3, 5</li> <li>● Guild RE</li> </ul>
A06		SRAM®	<ul style="list-style-type: none"> <li>● Red22(B1) Post Mount; Force 1, CX1 Post Mount; Rival22, Rival 1 Post Mount; Apex Post Mount, S700 HRD(B1)</li> </ul>
A07		SRAM®	<ul style="list-style-type: none"> <li>● Level Ultimate (A1), TLM (A1); Code RSC (A1), Code(B1)</li> </ul>
A08		SRAM®	<ul style="list-style-type: none"> <li>● Red eTap AXS HRD Monoblock (2019); Red eTap HRD (2017-2019); S900 Aero HRD (2017-2019)</li> </ul>

### SRAM®

Part No.	Description	Material / Finish
CCR023	 <p>Needle (Inserts) Fits SRAM® Stealth-a-majig System (Have to assemble with CCR024)</p> <p>油針 適用SRAM® Stealth-a-majig系統 必須搭配CCR024使用</p>	Stainless Steel/without finish 不銹鋼/本色
CCR024	 <p>Compression Bushing Fits SRAM® Stealth-a-majig System (Have to assemble with CCR023)</p> <p>迫緊環 適用SRAM® Stealth-a-majig系統 必須搭配CCR023使用</p>	Alloy/without finish 鋁/本色
CCA072I6	 <p>Compression Nut ( External ) Fits SRAM® System Juicy Series, CODE Series, Elixir Series, XX</p> <p>迫緊螺絲 (外牙式) 適用SRAM® 系統 Juicy, CODE, Elixir, XX系列</p>	Steel/Black 鐵/黑色
CCA124IA	 <p>Compression Nut Fits SRAM® System Red eTap AXS HRD Monoblock(2019); Red eTap HRD(2017-2019); S900 Aero HRD(2017-2019)</p> <p>迫緊螺絲 適用SRAM® 系統 Red eTap AXS HRD Monoblock(2019); Red eTap HRD(2017-2019); S900 Aero HRD(2017-2019)</p>	Steel/Chormed/Black 鐵/鎳/黑色

Part No.				Description	Material / Finish
<b>new</b> CCA135T9	E			Fitting 接頭螺絲	Stainless Steel/without finish 不銹鋼/本色
CCG040-B	F			Caliper-End Protector Fits Brake Lever End 保護套 適用於油壓碟剎把手端	Silicone Gel / Black 橡膠/黑色
CCG005	G			Caliper - End Protector Fits Brake Caliper End 保護套 適用於油壓碟剎卡鉗端	Silicone Gel / Black 橡膠/黑色
CCF051T9	H			Compression nut 壓著端端套	Stainless Steel/Silver 不銹鋼/本色
<b>new</b> CCF073AC	I			Compression nut (Assembled parts only) 壓著端端套 (以組件出貨)	Alloy/Anodized 鋁合金/陽極
<b>new</b> CCR074AB	K			Banjo end (Assembled parts only) 胡琴接頭 (以組件出貨)	Alloy/Anodized/Black 鋁合金/陽極/黑色
<b>new</b> CCR077AC	L			Banjo end (Assembled parts only) 胡琴接頭 (以組件出貨)	Alloy/Anodized 鋁合金/陽極
CC740	M			Needle Bolt Fits SRAM® System, Elixir Series 卡鉗端接頭 適用SRAM®系統, Elixir 系列	Stainless Steel/Silver 不銹鋼/本色
CCI010EB	N			O-Ring $\varnothing 6.0 \times 1.0$ O型環油封 $\varnothing 6.0 \times 1.0$	Polymer/Black 橡膠/黑色
<b>new</b> CCI034EB	O			O-Ring $\varnothing 7.0 \times 1.4$ O型環油封 $\varnothing 7.0 \times 1.4$	Polymer/Black 橡膠/黑色
<b>new</b> CCI035EB	P			O-Ring $\varnothing 7.4 \times 1.3$ O型環油封 $\varnothing 7.4 \times 1.3$	Polymer/Black 橡膠/黑色
<b>new</b> CCC075EB	Q			O-Ring $\varnothing 3.7 \times 1.5$ O型環油封 $\varnothing 3.7 \times 1.5$	Polymer/Black 橡膠/黑色
<b>new</b> CCC076EB	R			O-Ring $\varnothing 2.1 \times 1.5$ O型環油封 $\varnothing 2.1 \times 1.5$	Polymer/Black 橡膠/黑色
<b>new</b> CCC077EB	S			O-Ring $\varnothing 6.0 \times 1.5$ O型環油封 $\varnothing 6.0 \times 1.5$	Polymer/Black 橡膠/黑色
<b>new</b> CCC060JB	T			O-Ring $\varnothing 5.5 \times 1.2$ O型環油封 $\varnothing 5.5 \times 1.2$	Polymer/Black 橡膠/黑色



# HYDRAULIC SYSTEM

## Bicycle Hydraulic Disc Brake Parts

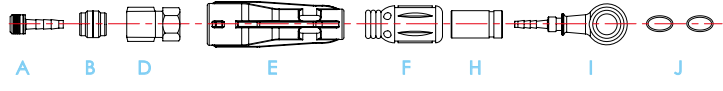
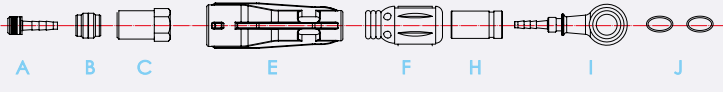
### Magura Hydraulic Hose fittings 油管接頭零件



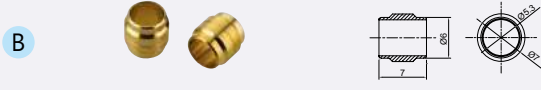
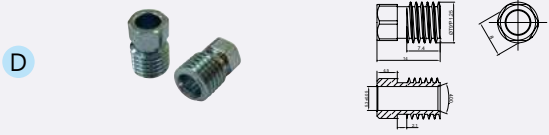



Part Number	Contain	Manufacturer	Compatible Models
<b>M03</b>		Magura®	<ul style="list-style-type: none"> <li>● MT Trail, MT8, MT7, MT6, MT5, MT4</li> </ul>
<b>M04</b>		Magura®	<ul style="list-style-type: none"> <li>● Gustav M 2000—2010</li> <li>● Marta 2007—2010</li> <li>● Marta Gold 2007</li> <li>● Marta SL 2008—2010</li> </ul>

### Magura

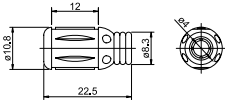
Part No.		Description	Material / Finish
<b>CC703</b>		Needle ( Insert ) Fits Magura® System 油針 適用Magura® 系統	Steel/ Chromed/Black 鐵/三價鉻鍍黑鋅/黑色
<b>CC707</b>		Compression Bushing Fits Magura® System 迫緊銅環 適用Magura® 系統	Brass/without finish 銅/本色
<b>CCA071110</b>		Compression nut ( External) Fits Magura® System 迫緊螺絲(外牙式) 適用Magura® 系統	Steel/ Chromed/Black 鐵/三價鉻鍍黑鋅/黑色
<b>CCA10211</b>		Compression nut ( External) Fits Magura® MT8,MT6,MT4,MT2 System 迫緊螺絲(外牙式) 適用Magura® MT8,MT6,MT4,MT2 系統	Steel/ Chromed 鐵/三價鉻鍍白鋅/本色
<b>CCG040-B</b>		Caliper-End Protector Fits Brake Lever End 保護套 適用於油壓碟剎把手端	Silicone Gel / Black 橡膠/黑色

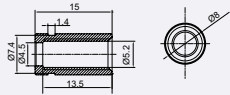

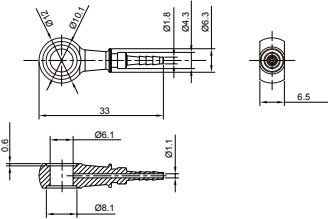

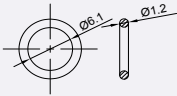
Part No.	Description	Material / Finish
CCG005 <span style="color: #00AEEF; border: 1px solid #00AEEF; border-radius: 50%; padding: 2px 5px;">F</span>	  <p>Caliper - End Protector Fits Brake Caliper End 保護套 適用於油壓碟刹卡鉗端</p>	Silicone Gel / Black 橡膠/黑色
CCF051T9 <span style="color: #00AEEF; border: 1px solid #00AEEF; border-radius: 50%; padding: 2px 5px;">H</span>	  <p>Compression nut (Assembled parts only) 壓著端端套 (以組件出貨)</p>	Stainless Steel/Silver 不銹鋼/本色
<span style="background-color: yellow; border-radius: 50%; padding: 2px;">new</span> CCR076AC <span style="color: #00AEEF; border: 1px solid #00AEEF; border-radius: 50%; padding: 2px 5px;">I</span>	  <p>Banjo end (Assembled parts only) 胡琴接頭 (以組件出貨)</p>	Alloy/Anodized 鋁合金/陽極
<span style="background-color: yellow; border-radius: 50%; padding: 2px;">new</span> CCI033NR <span style="color: #00AEEF; border: 1px solid #00AEEF; border-radius: 50%; padding: 2px 5px;">J</span>	  <p>O-Ring O型環油封</p>	NBR/Red 橡膠/紅色

# ACCESSORIES

## Housing Parts

### Formula Hydraulic Hose fittings 油管接頭零件

Part Number	Contain	Manufacturer	Compatible Models
<b>F01</b>		Formula®	● ORO
<b>F02</b>		Formula®	● R1R, R1, R0, RX, T1, Mega

### Formula®

Part No.	Description	Material / Finish
<b>CC775</b> <span style="color: #00AEEF;">A</span>	<p>Needle(Inserts) Fits Formula®-R1, THE ONE, MEGA System</p> <p>油針 適用Formula®-R1, THE ONE, MEGA系統</p>	Brass 銅/本色
<b>CC777</b> <span style="color: #00AEEF;">B</span>	<p>Compression Bushing Fits Formula®-R1, THE ONE, MEGA System</p> <p>迫緊環 適用Formula®-R1, THE ONE, MEGA系統</p>	Brass 銅/本色
<b>CC776</b> <span style="color: #00AEEF;">C</span>	<p>Compression Nut (External) Fits Formula®-R1, THE ONE, MEGA System</p> <p>迫緊螺絲(外牙式) 適用Formula®-R1, THE ONE, MEGA系統</p>	Steel/Silver 鐵/銀色
<b>CCG040-B</b> <span style="color: #00AEEF;">D</span>	<p>Caliper-End Protector Fits Brake Lever End</p> <p>保護套 適用於油壓碟剎把手端</p>	Silicone Gel / Black 橡膠/黑色
<b>CCG005</b> <span style="color: #00AEEF;">E</span>	<p>Caliper - End Protector Fits Brake Caliper End</p> <p>保護套 適用於油壓碟剎卡鉗端</p>	Silicone Gel / Black 橡膠/黑色
<b>CCF051T9</b> <span style="color: #00AEEF;">F</span>	<p>Compression nut (Assembled parts only)</p> <p>壓著端端套 (以組件出貨)</p>	Stainless Steel/Silver 不銹鋼/本色
<b>CCR075AC</b> <span style="color: #00AEEF;">G</span>	<p>Banjo end (Assembled parts only)</p> <p>胡琴接頭 (以組件出貨)</p>	Stainless Steel/Silver 不銹鋼/本色
<b>CC778</b> <span style="color: #00AEEF;">H</span>	<p>Compression nut Fits Formula®-ORO System</p> <p>胡琴接頭對鎖螺絲 適用Formula®-ORO系統</p>	Stainless Steel/Silver 不銹鋼/本色
<b>CC779</b> <span style="color: #00AEEF;">I</span>	<p>Banjo End Fits Formula®-ORO System</p> <p>胡琴接頭 適用Formula®-ORO系統</p>	Stainless Steel/Silver 不銹鋼/本色
<b>CCI010EB</b> <span style="color: #00AEEF;">J</span>	<p>O-Ring</p> <p>O型環油封</p>	Polymer/Black 橡膠/黑色

Hayes Hydraulic Hose fittings 油管接頭零件

Part Number	Contain	Manufacturer	Compatible Models
H01		Hayes®	<ul style="list-style-type: none"> <li>● Prime Expert</li> <li>● Prime Pro</li> <li>● Prime Comp</li> <li>● Stroker Trail</li> <li>● Stroker Carbon</li> <li>● Stroker Ace</li> <li>● Stroker Gram</li> </ul>
H02		Hayes®	<ul style="list-style-type: none"> <li>● Dyno Sport</li> <li>● Dyno Comp</li> <li>● Prime Sport</li> <li>● Radar</li> <li>● Stroker Ryde</li> </ul>

Hayes®

Part No.	Description	Material / Finish
CC914	<p>Needle Fits Hayes Hydraulic Hose</p> <p>油針 適用Hayes系列油管</p>	Brass 銅/本色
CC913	<p>Compression Nut 迫緊螺絲</p>	Steel/Black 鐵/黑色
CCG040-B	<p>Caliper-End Protector Fits Brake Lever End</p> <p>保護套 適用於油壓碟剎把手端</p>	Silicone Gel / Black 橡膠/黑色
CCG005	<p>Caliper - End Protector Fits Brake Caliper End</p> <p>保護套 適用於油壓碟剎卡鉗端</p>	Silicone Gel / Black 橡膠/黑色
CCF051T9	<p>Compression nut (Assembled parts only)</p> <p>壓著端端套 (以組件出貨)</p>	Stainless Steel/Silver 不銹鋼/本色
<span style="background-color: yellow; border-radius: 50%; padding: 2px;">new</span> CCR075AC	<p>Banjo end (Assembled parts only)</p> <p>胡琴接頭 (以組件出貨)</p>	Stainless Steel/Silver 不銹鋼/本色
CCI010EB	<p>O-Ring</p> <p>O型環油封</p>	Polymer/Black 橡膠/黑色

# ACCESSORIES

## Housing Parts

### Tektro Hydraulic Hose fittings 油管接頭零件

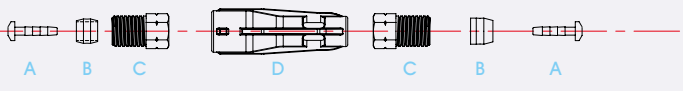
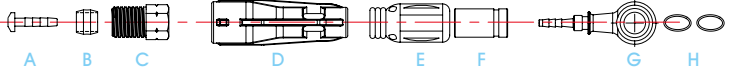
Part Number	Contain	Manufacturer	Compatible Models
T01		Tektro®	<ul style="list-style-type: none"> <li>● Auriga Comp</li> <li>● Auriga Comp WS</li> <li>● Draco</li> <li>● Draco WS</li> <li>● Draco 2</li> <li>● Gemini</li> </ul>
T02		Tektro®	<ul style="list-style-type: none"> <li>● Tektro® Auriga Pro</li> <li>● Gemini SL</li> <li>● Orion, Orion SL</li> <li>● Volans</li> <li>● TRP® Slate T4</li> <li>● Quadiem, Quadiem SL</li> <li>● Dash Carbon, Dash Sport</li> </ul>

Part No.	Description	Material / Finish
<p><b>new</b></p> <p><b>CM414</b></p> <p>A</p>  	<p>Needle Compatible with Jagwire Hydraulic Hose</p> <p>油針 適用Jagwire系列油管</p>	<p>Brass</p> <p>銅/本色</p>
<p><b>new</b></p> <p><b>CC1045</b></p> <p>B</p>  	<p>Compression Bushing</p> <p>迫緊環</p>	<p>Brass</p> <p>銅/本色</p>
<p><b>CCA072I6</b></p> <p>C</p>  	<p>Compression Nut ( External ) Fits SRAM® System Juicy Series, CODE Series, Elixir Series, XX</p> <p>迫緊螺絲 (外牙式) 適用SRAM®系統 Juicy, CODE, Elixir, XX系列</p>	<p>Steel/Black</p> <p>鐵/黑色</p>
<p><b>CCG040-B</b></p> <p>D</p>  	<p>Caliper-End Protector Fits Brake Lever End</p> <p>保護套 適用於油壓碟剎把手端</p>	<p>Silicone Gel / Black</p> <p>橡膠/黑色</p>
<p><b>CCG005</b></p> <p>E</p>  	<p>Caliper - End Protector Fits Brake Caliper End</p> <p>保護套 適用於油壓碟剎卡鉗端</p>	<p>Silicone Gel / Black</p> <p>橡膠/黑色</p>
<p><b>CCF051T9</b></p> <p>F</p>  	<p>Compression nut (Assembled parts only)</p> <p>壓著端端套 (以組件出貨)</p>	<p>Stainless Steel/Silver</p> <p>不銹鋼/本色</p>
<p><b>CC706</b></p> <p>G</p>  	<p>Banjo end (Assembled parts only)</p> <p>胡琴接頭 (以組件出貨)</p>	<p>Stainless Steel/Silver</p> <p>不銹鋼/本色</p>
<p><b>CCI010NR</b></p> <p>H</p>  	<p>O-Ring</p> <p>O型環油封</p>	<p>NBR/Red</p> <p>橡膠/紅色</p>



# DISC BRAKE PADS



## Comp 通用型

Jagwire Mountain disc brake pads are a great alternative to OEM. They feature a high performance, yet low-noise semimetallic compound mounted to a steel backing plate.

- 使用高質量鐵材質背版
- 複合式磨耗材質適用於一般氣候使用
- 低噪音、耐磨耗



## Comp Organic 有機通用型

Jagwire Comp Organic pads feature an all-new resin compound. Mounted on a steel backing plate, this compound gives good power and modulation, while keeping noise to a minimum. Great for riders primarily riding in dry conditions.

- 使用高質量鐵材質背版
- 搭配特殊有機物質磨耗材質適用於一般氣候使用
- 低噪音



## Lite 輕量型

Lite pads feature a lightweight aluminum backing plate attached to the same quiet and high-performance semi-metallic compound found on our Mountain Sport series disc pads. Weight is reduced by nearly 50%. These pads are perfect for cross-country applications.

- 輕量化鋁合金背版，重量較為標準款碟煞來令片輕50%
- 複合式磨耗材質適用於一般天候、路況使用
- 低噪音、耐磨耗



## Heavy Duty 耐用型

Mountain Pro Extreme pads feature an aggressive sintered compound that provides maximum stopping power making it perfect for DH riding. The dense, sintered compound also resists water making it extremely effective in wet conditions.

- 燒結來令片，長效能、耐磨耗的特性，給您更專業的煞停效果
- 專為濕式、泥濘路況或下坡賽道重量級車款設計使用











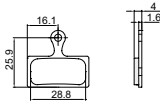

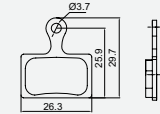
## E-Bike 電動車

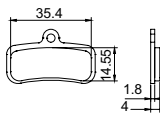

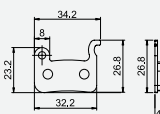
E-bike disc brake pads are tuned to provide additional stopping power and durability. They also offer consistent modulation with little braking noise. Designed for the unique demands of pedal-assist E-bikes, these pads are perfect for both city E-bikes and E-MTBs.

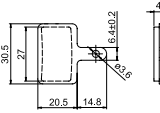
- 電動車專用磨耗材質
- 完美搭配城市電動車與電動登山車
- 低噪音

## Shimano®

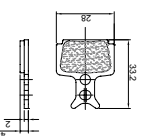

Brake Model	Comp 通用型	Comp Organic 有機通用型	Lite 輕量型	Heavy Duty 耐用型	E-Bike 電動車		
XTR M9020, M9000, M987, M985; Deore XT M8100, M8000, M785; SLX M7100, M7000, M675, M666; Deore M6000, M615; Alfine S700; Road/CX RS785, R785, CX77, CX75, R517, R515, R317, R315			<b>DBL641-4</b>	<b>DBL641-7</b>	<b>DBL641-1</b>	<b>DBL731-1</b>	<b>DBL641-12</b> 
XTR M9100; Dura Ace R9170; Ultegra R8070; 105 R7070; Tiagra 4770; GRX RX810, RX400; Road/CX RS805, RS505, RS405, RS305; Metrea U5000			<b>DBL505-1</b>	<b>DBL505-4</b>	<b>DBL505-5</b>	<b>DBL505-9</b>	N/A
XTR M9120; Saint M820, M810; Deore XT M8120, M8020; SLX M7120; ZEE M640; Non-Series MT520, MT420			<b>DBL762-2</b>	<b>DBL762-3</b>	N/A	<b>DBL762-1</b>	<b>DBL762-7</b> 
XTR M975, M966, M965, Saint M800, Deore XT M776, M775, M765, SLX M665, Deore LX T665, M585, Hone M601, Deore M596, M595, M535, Alfine S501, S500, Non-Series T605, R505, M545			<b>DBL390-1</b>	N/A	N/A	N/A	N/A
Deore LX T675, Deore T615, M525, M515, M515-LA, Alivio M4050, Acera M3050, Nexave C601, C501, Tourney TX805, Non-Series MT500, MT400, MT200, M575, M486, M485, M475, M465, M447, M446, M445, M416, M416A, M415, M395, M375, M365, M355, M315, UR300			<b>DBL370-1</b>	<b>DBL371-9</b>	N/A	N/A	<b>DBL370-4</b> 

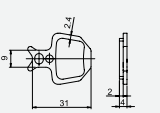
## Formula®





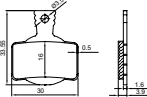

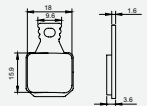



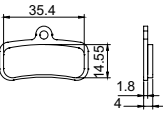

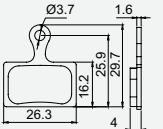
Brake Model	Comp 通用型	Comp Organic 有機通用型	Lite 輕量型	Heavy Duty 耐用型	E-Bike 電動車		
R1R, R1, C1, CR3, T1R, T1, ROR, RO, Cura			<b>DBL581-2</b>	<b>DBL581-6</b>	<b>DBL580-4</b>	<b>DBL711-1</b>	N/A
ORO			<b>DBL401</b>	N/A	N/A	N/A	N/A

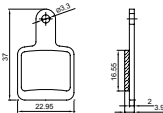
# DISC BRAKE PADS

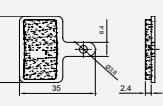
## Magura®

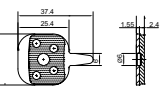

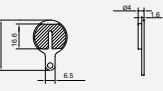

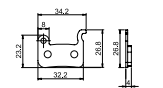

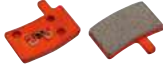
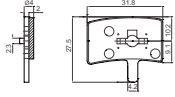

Brake Model	Comp 通用型	Comp Organic 有機通用型	Lite 輕量型	Heavy Duty 耐用型	E-Bike 電動車		
MT8 SL, MT8 Pro, MT8, MT8 SL Flatmount, MT Trail SL (Rear), MT Trail Sport (Rear), MT6, MT4, MT4 Flatmount, MT4e, MT2, MT Sport			DBL671-1	DBL671-4	DBL671-3	N/A	DBL671-5
MT7 Pro, MT7, MT Trail SL (Front), MT Trail Sport (Front), MT5, MT5e			DBL761-1	DBL761-2	N/A	N/A	DBL761-3

## Tektro®, TRP®

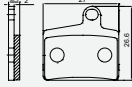

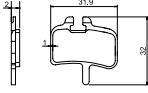
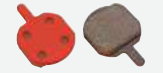
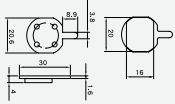
Brake Model	Comp 通用型	Comp Organic 有機通用型	Lite 輕量型	Heavy Duty 耐用型	E-Bike 電動車		
TRP® Quadiem, G-Spec Quadiem, Slate T4, G-Spec Slate, G-Spec DH, Zurich; Tektro® Orion 4P, Dorado 4P			DBL762-2	DBL762-3	N/A	DBL762-1	 DBL762-7
TRP® Hylex Flat Mount, Hylex RS Flat Mount, HD-T910; Tektro® HD-R510, HD-R310			DBL505-1	BDL505-4	DBL505-5	DBL505-9	N/A
Tektro® Volans, Auriga Twin, Auriga SUB, Auriga E-SUB, TRP® Parabox 2011 Rear			DBL681-1	N/A	N/A	N/A	N/A
TRP® HY/RD Post Mount, Hylex Post Mount, Hylex RS Post Mount, Parabox 2012, Slate X2, Spyre, Spyre SLC, Spyke; Tektro® Aquila, Auriga, Auriga E-Comp, Auriga E-Tune, Auriga E-Twin, Auriga Pro, Auriga Tune, Dorado HD-E715, Draco, Draco 2, Draco WS, Gemini, HD-E350, HD-M285, HD-M286, HD-T285, HDC330, Junior, MD-C510, Orion, Orion SL, Vela			DBL370-1	DBL371-9	N/A	N/A	 DBL370-4
Tektro® IO			DBL561	N/A	N/A	N/A	N/A
Tektro® Lyra			DBL570-1	N/A	N/A	N/A	N/A
TRP® Dash, Dash Carbon, Parabox 2011 Front			DBL390-1	N/A	N/A	N/A	N/A

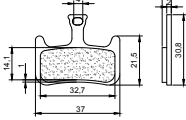

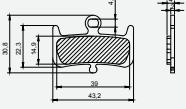
## Hayes®

Brake Model	Comp 通用型	Comp Organic 有機通用型	Lite 輕量型	Heavy Duty 耐用型	E-Bike 電動車	
Stroker Trial, Stroker Carbon, Stroker Gram			DBL600-1	N/A	N/A	N/A
Dyno, Stroker Ryde			DBL610-1	N/A	N/A	N/A
HFX-Mag Series, HFX-9 Series, MX1			DBL300-1	N/A	N/A	N/A
Sole, MX2, MX3, MX4, MX5, CX5			DBL430-1	N/A	N/A	N/A
<b>new</b> Dominion A2, Dominion T2			DBL776	N/A	N/A	N/A
<b>new</b> Dominion A4			DBL775-AL	N/A	N/A	N/A

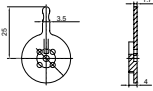
## Promax®

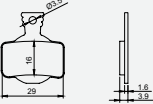
Brake Model	Comp 通用型	Comp Organic 有機通用型	Lite 輕量型	Heavy Duty 耐用型	E-Bike 電動車	
Render, Render R, Decipher, DSK-330, DSK-330R, DSK-310, DSK-300, DSK-300R, DC913, DC720, DC710			DBL460-1	DBL461-2	N/A	N/A
F1, Solve, Solve-ST, Lucid, Decode R, eCapsule, DSK-909			DBL370-1	DBL641-7	N/A	<b>new</b> DBL370-4

## RST®

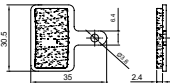
Brake Model	Comp 通用型	Comp Organic 有機通用型	Lite 輕量型	Heavy Duty 耐用型	E-Bike 電動車	
D-Power			DBL370-1	DBL371-9	N/A	<b>new</b> DBL370-4



# Brake Pads

煞車皮

## Brake Pad Compounds



- All-around performance
- Long wear

AW: 絕佳耐用效能 · 優異煞車效能適用於全路況



- Designed for wet weather control

Wet: 專為濕地路況設計增加製動力



- Specifically designed for carbon fiber braking surfaces

Carbon: 適用於Carbon輪圈

# BRAKE PADS

適用於C夾公路車(Shimano 或 SRAM)專用

Part No.	Description	Material / Color
<p><b>P491AAW</b></p> 	<p>Road Pro Skeleton Series 輕量化系列</p> 	<p>AW/Silver/Alloy/PVD Length:50mm AW/銀色/鋁/PVD鈦色/50mm</p>
<p><b>P495AAW</b></p> 	<p>Road Pro Skeleton Series 輕量化系列</p> 	<p>AW/Black/Alloy/PVD Length:50mm AW/黑色/鋁/PVD鈦色/50mm</p>
<p><b>P431AAW</b></p> 	<p>Road Sport 基本款系列</p> 	<p>AW/Black/Alloy/PVD Length:50mm AW/黑色/鋁/PVD鈦色/50mm</p>
<p><b>P433AAW</b></p> 	<p>Road Sport 基本款系列</p> 	<p>AW/Black/Alloy/PVD Length:50mm AW/黑色/鋁/PVD鈦色/50mm</p>
<p><b>P453R</b></p> 	<p>Elite Road inserts 公路車更換式煞車皮</p> 	<p>AW/Black Length:50mm AW/黑色/50mm</p>
<p><b>P453RXR</b></p> 	<p>Elite Road Red Zone inserts 公路車更換式煞車皮(濕式)</p> 	<p>RZ/Red Length:50mm RZ/紅色/50mm</p>
<p><b>P453RNU</b></p> 	<p>Elite Road Carbon inserts 公路車更換式煞車皮(Carbon)</p> 	<p>Carbon/Blue Length:50mm Carbon/藍色/50mm</p>

# 煞車皮



適用於C夾公路車(Campagnolo)專用

Part No.	Description	Material / Color
<b>P402A</b>  	Road Pro Skeleton Series 輕量化系列	AW/Black /Alloy/ Black / Length:54mm AW/黑色/鋁/黑色/54mm
<b>P475AAB</b>  	Road Sport 基本款系列	AW/Black /Alloy/ Black Length:54mm AW/黑色/鋁/黑色/54mm
<b>P459RAB</b>  	Road Inserts 公路車替更式煞車皮	AW/Black/ Length:54mm AW/黑色/54mm
<b>P403RAB</b>  	Campagnolo 2012+ Inserts Campagnolo 2012+ 更換式煞車皮	AW/Black/ Length:54mm AW/黑色/54mm

適用於公路車基本款系列

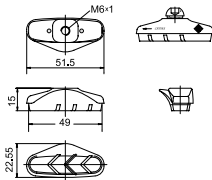
Part No.	Description	Material / Color
<b>P451A</b>  	Basics comp road brake 公路車基本款	AW/Black/Length:50mm AW/黑色/50mm

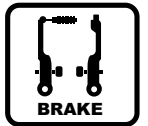

適用於V夾登山車專用

Part No.	Description	Material / Color
<b>P91AC</b>  	V Brake Compatible 整組登山車系列 (V型夾器專用)	AW/Black /Alloy/ Black Length:70mm AW/黑色/鋁/黑色/70mm
<b>P91BC</b>  	V Brake Compatible 整組登山車系列 (V型夾器專用)	AW/Black /Alloy/ Silver Length:70mm AW/黑色/鋁/銀色/70mm
<b>P919V</b>  	Canti Brake Compatible 整組登山車系列 (懸吊式夾器專用)	AW/Black /Alloy/ Black Length:70mm AW/黑色/鋁/黑色/70mm
<b>P908C</b>  	V Brake Compatible 整組登山車系列 (V型夾器專用)	AW/Black /Alloy/ Silver Length:70mm AW/黑色/鋁/銀色/70mm



# BRAKE PADS



適用於V夾登山車專用

Part No.	Description	Material / Color
<b>P91DR</b>  	Brake Pad inserts 登山車更換式煞車皮	AW/Black Length:70mm AW/黑色/70mm
<b>P91DRZ</b>  	Brake Pad inserts 登山車更換式煞車皮	RZ/Red Length:70mm RZ/紅色/70mm
<b>P90XR</b>  	Brake Pad inserts 登山車更換式煞車皮	BS/Black Length:70mm BS/黑色/70mm
<b>P90XRXR</b>  	Brake Pad inserts 登山車更換式煞車皮	RZ/Red Length:70mm RZ/紅色/70mm

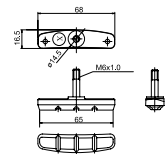
適用於登山車懸臂V夾基本款系列

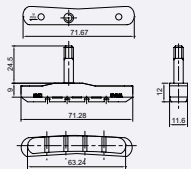
Part No.	Description	Material / Color
<b>P909T</b>  	Compatible V Brake 整組登山車系列 (V型夾器專用)	AW/Black Length:70mm AW/黑色/70mm
<b>P908T</b>  	Compatible V Brake 整組登山車系列 (V型夾器專用)	AW/Black Length:70mm AW/黑色/70mm

適用於登山車懸臂V夾基本款系列

Part No.	Description	Material / Color
<b>P908T-Y</b> 	 <p>Compatible V Brake 整組登山車系列 (V型夾器專用)</p>	AW/Black/Yellow Length:70mm  AW/黑色/黃色/70mm
<b>P908T-R</b> 	 <p>Compatible V Brake 整組登山車系列 (V型夾器專用)</p>	AW/Black/Red Length:70mm  AW/黑色/紅色/70mm
<b>P908T-P</b> 	 <p>Compatible V Brake 整組登山車系列 (V型夾器專用)</p>	AW/Black/Pink Length:70mm  AW/黑色/粉紅色/70mm
<b>P908T-B</b> 	 <p>Compatible V Brake 整組登山車系列 (V型夾器專用)</p>	AW/Black/Blue Length:70mm  AW/黑色/藍色/70mm
Part No.	Description	Material / Color
<b>P908T-G</b> 	 <p>Compatible V Brake 整組登山車系列 (V型夾器專用)</p>	AW/Black/Gray Length:70mm  AW/黑色/灰色/70mm
<b>P947T</b> 	 <p>Compatible V Brake 整組登山車系列 (V型夾器專用)</p>	AW/Black/Yellow Length:70mm  AW/黑色/黃色/70mm
<b>P908H</b> 	 <p>Compatible Canti Brake 整組登山車系列 (懸吊式夾器專用)</p>	AW/Black Length:70mm  AW/黑色/70mm
<b>P909H</b> 	 <p>Compatible Canti Brake 整組登山車系列 (懸吊式夾器專用)</p>	AW/Black Length:70mm  AW/黑色/70mm
<b>P910H</b> 	 <p>Compatible Canti Brake 整組登山車系列 (懸吊式夾器專用)</p>	AW/Black Length:55mm  AW/黑色/55mm
<b>P900H</b> 	 <p>Compatible Canti Brake 整組登山車系列 (懸吊式夾器專用)</p>	AW/Black Length:70mm  AW/黑色/70mm

## Exploring New Horizons for Control Systems

For more than 20 years, Jagwire has pioneered new territory in the manufacture of high performance control systems. As an ISO 9001/TS-16949 company we have an unyielding commitment to quality.

### Faster, Leaner, Better

Fully committed to process improvement, our experienced engineering staff is always looking for ways to enhance quality, reduce errors and increase customer satisfaction. Partnering with Toyota, we integrated the highly efficient Toyota Production System (TPS). Our balanced blend of automation and manual processes helps us manage flow and volume, resulting in unsurpassed quality and efficiency. And as a member of the Taiwan A-Team manufacturing group, we develop improved business strategies and tactics to reduce lead times, improve quality and cut defects and waste.

## Environment & Community

Recognizing our vital role as responsible global citizens, we strive to produce products that meet the exacting requirements of government agencies for performance, safety and environmental impact. Our primary control system products are CPSIA, Proposition 65 and CEN certified.

## Chia Cherne Industry Company, Ltd Warranty Policy

### EXTENT OF LIMITED WARRANTY

Chia Cherne/Jagwire warrants its products to be free from defects in materials or workmanship for a period of two years after original purchase. This warranty only applies to the original owner and is not transferable. Claims under this warranty must be made through the retailer where the bicycle or the Jagwire product was purchased. Original proof of purchase is required. Complete product warranty information is available by visiting [jagwire.com](http://jagwire.com). Or a copy may be requested via email.

Email: [info@jagwire.com](mailto:info@jagwire.com)

## Product Safety & Installation

**WARNING:** Many bicycle service and repair tasks require special knowledge and tools. In order to help minimize the chances of an accident and possible injury, it is critical that you have any installation, repair or maintenance performed by a professional bicycle mechanic or dealer. Do not begin any adjustments or service on your bicycle yourself until you have learned from your mechanic or dealer how to properly complete them. Improper adjustment or service may result in damage to the bicycle or an accident, which can cause serious injury or death.

Consult your dealer or mechanic for help in determining your maintenance requirements. Like any mechanical device, a bicycle and its components are subject to wear and stress. Different materials and mechanisms wear or fatigue from stress at different rates and have different life cycles. If a component's life cycle is exceeded, the component can fail, causing serious injury or death to the rider. Scratches, cracks, fraying of wires and discoloration are signs of stress-caused fatigue and indicate that a part is at the end of its useful life and needs to be replaced. While the materials and workmanship of bicycle components may be covered by a warranty for a specified period of time by the manufacturer, this is no guarantee that the product will last the term of the warranty. Product life is often related to riding style and product care. A component warranty is not meant to suggest that the component cannot be broken or will last forever.

Before installing any component or accessory make sure that it is compatible with your bicycle by checking with your dealer.

### WARNING:

1. Riding with improperly adjusted brakes, worn brake pads, worn control cables or housings is dangerous and can result in serious injury or death.
2. Applying brakes too hard or too suddenly can lock up a wheel, which could cause you to lose control and fall. Sudden or excessive application of the front brake may pitch the rider over the handlebars, which may result in serious injury or death.
3. Some bicycle brakes, such as disc brakes and linear-pull brakes are extremely powerful. Take extra care in becoming familiar with these brakes and exercise particular care when using them.
4. Disc brakes can get extremely hot with extended use. Be careful not to touch a disc brake until it has had plenty of time to cool.
5. See the brake manufacturer's instructions for operation and care of your brakes. If you do not have the manufacturer's instructions, see your dealer or contact the brake manufacturer.

**WARNING:** Jagwire cables, housings and brake pads are not intended for use on any motorized bicycle or vehicle. Any such use could result in a serious personal injury.

## Brake Inspection

**Inspecting your bicycle's braking systems before each ride is critical to your safety. Check the brakes for proper operation.**

- Squeeze the brake levers
- Are the brake quick-releases closed?
- All control cables seated and securely engaged?
- Do the brake pads contact the wheel rim squarely and make full contact with the rim?
- Are the bolts that attach your brake pads to the brake caliper tight?
- Do the brake pads touch the wheel rim within an inch of brake lever movement?
- Can you apply full braking force at the levers without having them touch the handlebar?

If not, your brakes need adjustment. Do not ride the bike until the brakes are properly adjusted by a professional bicycle mechanic.

The effectiveness of braking is dependent on environmental factors and equipment condition over which Jagwire has no control. Consult the owner's manual for your bicycle and a professional bike mechanic or dealer to learn more about proper braking techniques and always practice riding and braking techniques on a flat and level surface prior to riding.

Under wet conditions, the stopping power of your brakes is dramatically reduced. In wet conditions, ride slowly and apply your brakes earlier than you would under normal, dry conditions.

Inspect your brakes, cables and brake pads regularly for damage, and always inspect them thoroughly after any crash or severe impact. If you detect damage, please have your bicycle inspected by a professional bike mechanic or dealer.

Important: If the brake pads are worn until the grooves disappear, replace them with new pads. If wheel rims are excessively worn from braking, replace them with new rims.

## Cables

Improper set-up or use of brake control cables can result in loss of control or lead to a serious accident, which could lead to a severe injury.

It is your responsibility to ensure that your brake control system cables are functioning properly before each ride. Consult the owner's manual for your bicycle and a professional bike mechanic or dealer to learn more about proper cable installation and maintenance techniques.

Inspect your cables & housings regularly for damage or wire fraying, and always inspect them thoroughly after any crash or severe impact. If you detect damage, please have your bicycle inspected by a professional bike mechanic or dealer.

Important: If your control system wires begin to fray, your housing end caps show any signs of damage or your housing is kinked, replace them with new products.

### Installation Assistance

Downloadable instructions are available on [www.jagwire.com](http://www.jagwire.com), or by contacting Jagwire directly.

Europe - [jageurope@nowcompany.com](mailto:jageurope@nowcompany.com)

Asia - [service@jagwire.com.tw](mailto:service@jagwire.com.tw)

North & South America - [tech@jagwire.com](mailto:tech@jagwire.com)

## Trademarks

All trademarks, service marks and trade names of Jagwire and Chia Cherne used herein are trademarks or registered trademarks of the Chia Cherne Industry Company, Ltd. Use of any trademarks or other intellectual property of Chia Cherne, without the express written consent of Chia Cherne, is prohibited.

Copyright (c) 2020—Chia Cherne Industry Company, Ltd.

## We Support:







## **HEAD OFFICE CHIA CHERNE TAIWAN**

No. 55, Alley 121  
Lane 175, Kousheng Rd.  
Changhua City, Taiwan  
Ph: +886.4.732.3090  
Fx: +886.4.732.1824  
service@jagwire.com.tw

## **CHIA CHERNE EUROPE**

Klein Frankrijkstraat 24  
9600 Wavre  
Belgium  
Ph: +32 55 30 41 65  
Fx: +32 55 30 42 65  
info@jagwire-europe.com

## **CHIA CHERNE CHINA - KUNSHAN**

1465 Hongshu Rd,  
Kunshan Economic & Technical Development Zone,  
Jiangsu Province, China  
Ph: +86 512 5016 5058  
Fx: +86 512 5016 5060  
jcac@jagwire.com.tw

## **CHIA CHERNE CHINA - SHENZHEN**

Haosan Shangxing  
Industrial Zone No. 71  
Nanhuan Road, Shajing Town  
Boan Zone, Shen Zen City  
P.C.518125, China  
Ph: +86 755 2727 2835  
Fx: +86 755 2727 2837  
service@jagwire.com.cn

## **CHIA CHERNE VIETNAM - KAKOSI CO., LTD**

Khu Công Nghiệp Bình Xuyên, Thị trấn Hương  
Cánh, Huyện Bình Xuyên, Tỉnh Vĩnh Phúc  
Ph: +84 (211) 222 2567 (Ext 101)  
Fx: +84 (211) 222 2555  
kakosi\_lin@hotmail.com

